

AquaEfficiency Quick installation guide

Domestic hot water system

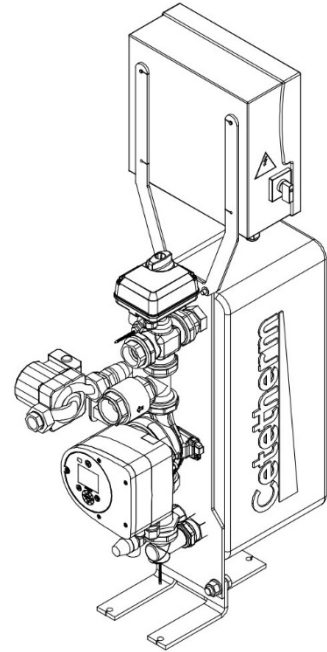

Content

1	General information	2
1.1	Information about the document	2
2	Electrical installation	2
2.1	Open the control box	2
2.2	Electrical wiring diagram	3
2.2.1	Power terminal	3
3	Operator control panel Micro 3000	4
3.1	Set the time and date	5
3.2	Changing the Date format	5
3.3	Set the hot water temperature.....	6
4	Factory reset of the control panel	7
4.1	Spara inställningar och parametrar	7
4.2	See saved settings and parameters.....	8
5	Factory reset	8

DOC1585 2020-09-02

This manual is published by Cetetherm.

Cetetherm can without further notice make changes and improvements to the content in this manual if it is necessary due to printing mistakes, wrong information or changes in the hardware or software.

All these types of changes will be included in future release of the manual.

1 General information

This is a short guide to quickly get started with your AquaEfficiency.

For more information please see the complete manual at <https://www.cetetherm.com/en/products/tap-water-systems/aquaefficiency>.

1.1 Information about the document

All pictures in this document are general images.

AquaEfficiency is available in different models and levels of equipment.

2 Electrical installation

Power supply the control box with 230VAC 50 Hz and secure with an 6A fuse.



AquaEfficiency must be protected with an earth-fault breaker.



The control box must be wired to ground.

Check that Neutral and Phase are connected to the correct terminal.

2.1 Open the control box

Remove the front panel by turning the lock button counter clockwise and lift the cover.



Unscrew the two screws in bottom and lift the panel.

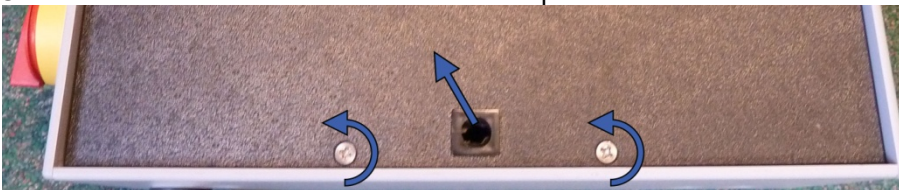

2.2 Electrical wiring diagram

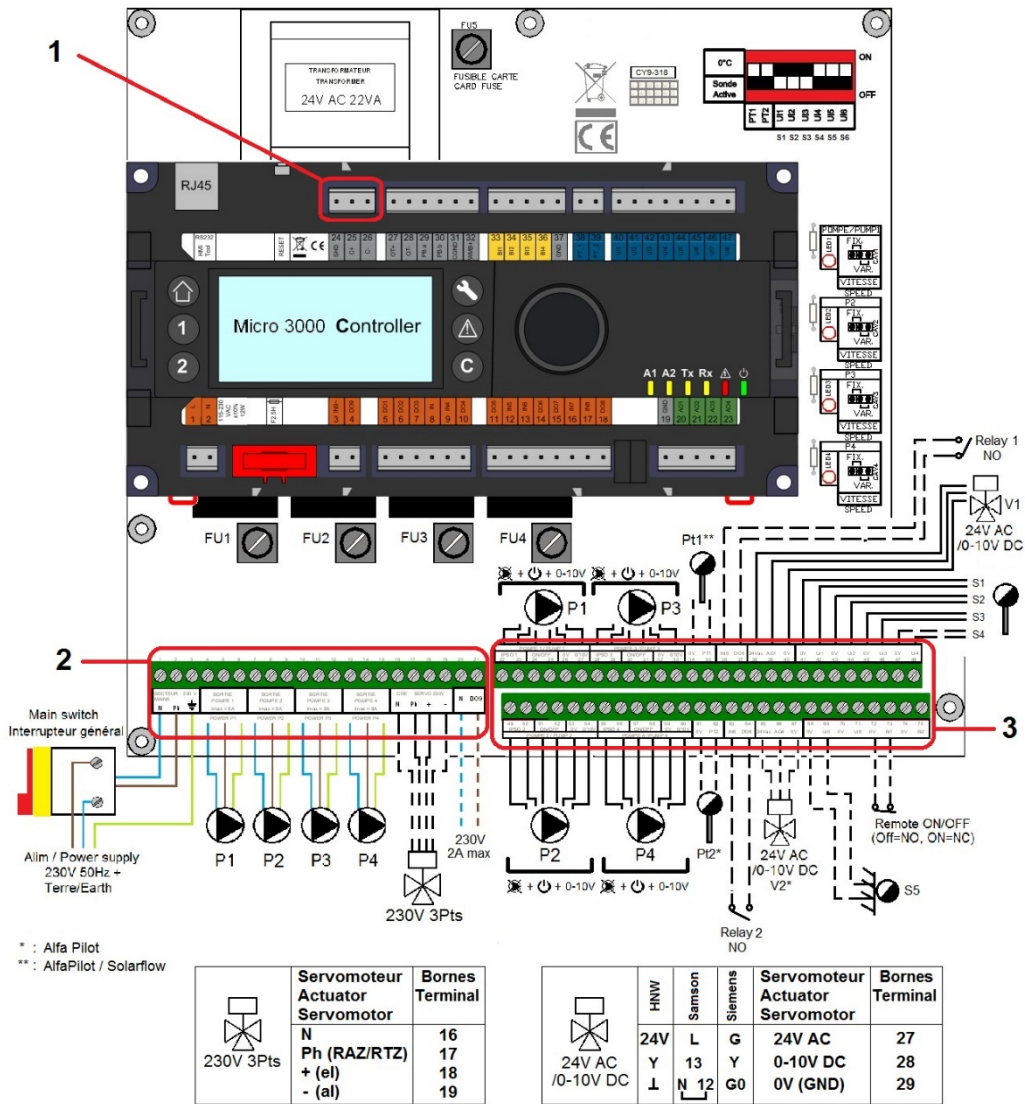

2.2.1 Power terminal













230V output to pumps and valves

1	2	3	4	5	6	7	8	9	10	11	12	13	14	15	16	17	18	19	20	21
N	Ph	⊥	N	Ph	⊥	N	Ph	⊥	N	Ph	⊥	N	Ph	⊥	N	Ph	+	-	N	DO9
Main power 230V			Pump1			Pump2			Pump3			Pump4			CDE Servo			230V Triac output		

3 Operator control panel Micro 3000



Status LED

Button	Function
	Rotary button, wheel, for scrolling through the menus. Access sub-menus and change settings by pressing it. To activate the line or change a highlighted value, simply press the wheel. Works like an Enter key.
	Press to exit a level and return to the previous menu/parameter. Works like an ESC key.
	Press to access the maintenance / monitoring menu. NOTE: Requires a password.
	Press to go to the Home screen, Main Menu
	Press to access the Alarm Menu.
	Not used
	Not used
	Relay 1 activated
	Relay 2 activated
	Active data transmission
	Active data reception
	Alarm indicator
	The Control box is switched on.

3.1 Set the time and date

1. Turn the wheel anticlockwise to highlight the line with time and date at the top of the screen. Press the wheel to enter the Date/Time menu.

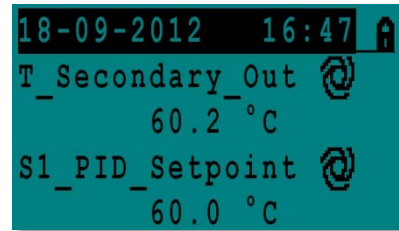

2. Press the wheel to change the first variable, the year.
3. When the year flashes, increase or reduce the set value by rotating the wheel. Once the right value is displayed, press the wheel to confirm the setting. Next parameter to change starts to flash.
4. Proceed in the same way to set the month, date and time (hour: minute).

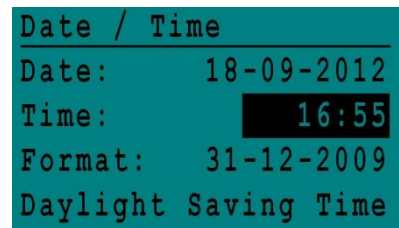
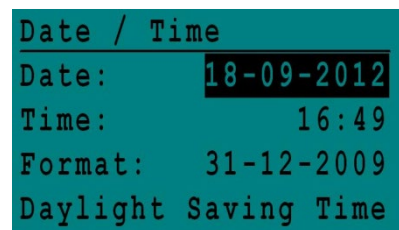

3.2 Changing the Date format

In the Date/Time menu the date format can be changed.

Choose between the following formats:

- yyyy-mm-dd
- mm-dd-yyyy
- dd-mm-yyyy
- dd.mm.yyyy
- dd/mm/yyyy



3.3 Set the hot water temperature

Please set a hot water production temperature in line with current national legislation and recommendations.

NOTE! Cetetherm recommends the hot water temperature is at least 55 °C and a hot water circulation not less than 50 °C.

With a temperature below 50 °C there is an increased risk of bacterial growth.

Note that at temperatures above 60 °C the risk of scalding increases.

Set points above 63 °C result in an increased risk of precipitation of lime scaling on the surfaces of the heat exchanger.

The DHW set point SP_T_Sec_Outlet, is set to 55 °C by default, at any time, all the days of the week.

Add extra temperature set points at different times of the day.

These changes will be reported to all days with the time program week, excluding the weekend time program.

1. Press the  to go back to the Main Menu, choose "S1 Menu.Sec Outlet", press the wheel.
2. Use the wheel and mark the clock logo, press the wheel.

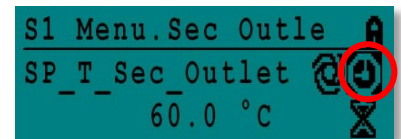

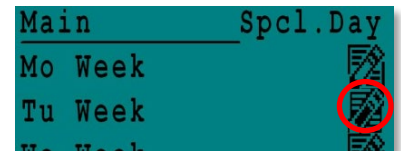

3. Mark the day you want to change, press the wheel.

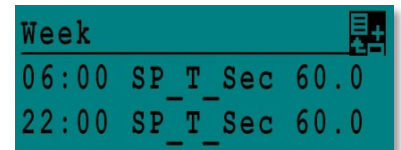

4. Change a time or temperature.
Mark the line and press the wheel. Change the value by turning the wheel.
Confirm the new setting by pressing the wheel.



5. Add a new time or set point; choose .
6. To delete a time or set point; choose; .

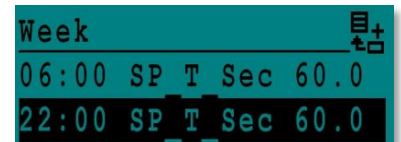

In this example the set point is 60°C at 22h00. .

4 Factory reset of the control panel

Save settings like number of pumps and parameter settings to an EEPROM before reset of the control panel. After the reset the parameters can be reloaded.

4.1 Spara inställningar och parametrar

1. Press the -key to open the Service menu, select "Login Installer", press the wheel.

Enter the password "3333", press the wheel to confirm.

2. Select "Continue", press the wheel.

3. Select "System data" and then "Flash Memory", press the wheel.

4. Choose the first "Save Application", press the wheel.
All parameters are now saved to an EEPROM and can be reloaded after a reset.



```
Service Menu
-----
Continue
Login Installer
```

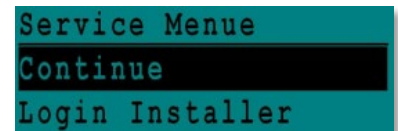

```
Service Menu
-----
Continue
Login Installer
```



```
Service
-----
Interface Config
Time Program
Point Data
System Data
```

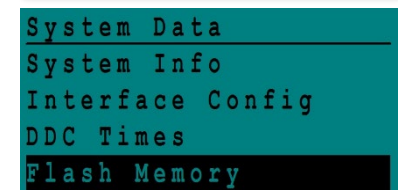

```
System Data
-----
System Info
Interface Config
DDC Times
Flash Memory
```

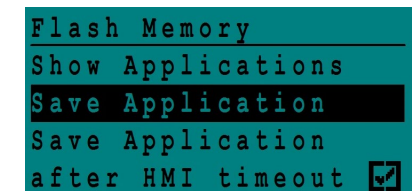

```
Flash Memory
-----
Show Applications
Save Application
Save Application
after HMI timeout 
```

4.2 See saved settings and parameters

1. Press the -key to open the Service menu, select "Login Installer", and press the wheel.

Enter the password "3333", press the wheel to confirm.



2. Select "Continue", press the wheel.

3. Select "System data" and then "Flash Memory", press the wheel.

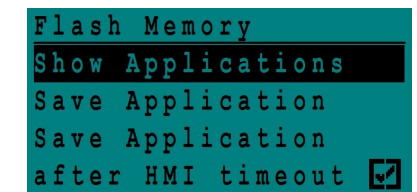
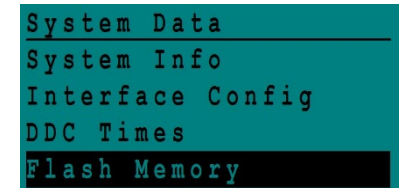
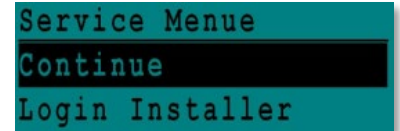
4. Select "Show application", press the wheel to see a list of all saved configurations, saved with date and time.



5 Factory reset

1. Press both  and  for 5 seconds.
2. Rotate the wheel and select in the list the language used in the controller, English (n).

The number between brackets indicates that parameters have been saved.

3. Press the wheel a few seconds and choose the type of reset you like to do:
 - Factory- reset to factory settings
 - English – reset using your saved settings
4. The controller will restart in a few minutes.

