

Cetetherm

Installation, service and operating instruction Cetetherm Micro

Heating & domestic hot water substation for apartments and single family houses

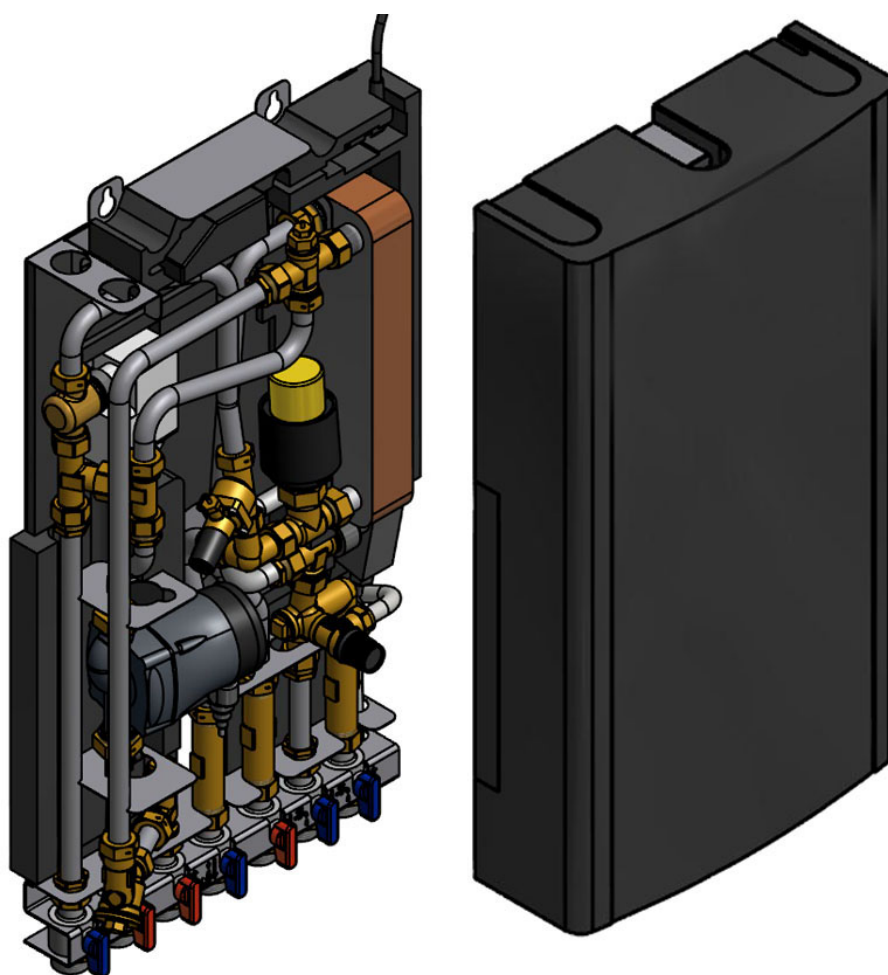

This manual is published by Cetetherm.

Cetetherm can without further notice make changes and improvements to the content in this manual if it is necessary due to printing mistakes, wrong information or changes in the hardware or software.

All these types of changes will be included in future release of the manual.

Contents

1	General information.....	6
1.1	Comfort.....	6
1.2	Installation.....	6
1.3	Long-term security.....	6
1.4	CE-marking.....	6
1.5	General warnings.....	7
1.6	Micro STC and Micro STC2 warnings.....	7
2	Operating instructions.....	8
2.1	General operation.....	8
2.2	Heating operation Micro STC and Micro STC2.....	8
2.3	Heating operation Micro RTC.....	8
2.4	Safety equipment/inspection.....	8
3	Product overview.....	9
3.1	Product overview AquaMicro.....	9
3.2	Product overview Micro DPC.....	10
3.3	Product overview Micro RTC.....	11
3.4	Product overview Micro STC.....	12
3.5	Product overview Micro STC2.....	13
3.6	Product overview Micro HTC.....	14
3.7	Symbols on the first fix-jig.....	14
4	Installation.....	15
4.1	Unpacking.....	15
4.2	Preparation.....	15
4.3	Mounting.....	15
4.4	Mounting options general.....	16
4.4.1	Mounting options Micro STC and Micro STC2.....	16
4.5	Adjustments and settings general.....	16
4.5.1	Adjustments and settings With a Micro HTC:.....	16
4.6	Commissioning advice Micro STC and Micro STC2.....	17
4.7	Dismantlement.....	17
4.8	User instruction HTC hot water actuator.....	17
4.9	Installing the room thermostat Round.....	18
4.10	Installing the control panel CM737.....	19
4.11	Installing the outdoor temperature sensor.....	21
4.12	Starting up sequence with component check.....	21
5	CM737- settings to be done after start-up.....	22
5.1	Configure the control panel after installation.....	22
5.2	Setting the day.....	22
5.3	Setting the time.....	22
6	Room thermostat Round.....	23
6.1	General.....	23
6.2	Control modes.....	24
6.3	Changing control mode, OTC heating curve and max supply temperature.....	24
6.4	OTC control mode, default setting.....	25
6.5	Viewing the room temperature.....	25
6.6	Viewing the set room temperature.....	25
6.7	Changing temperature setting.....	25
6.8	Setback.....	25
6.9	Summer heating.....	25
6.10	Display symbols.....	26
6.11	Fault messages on the room thermostat.....	27
6.12	Fault codes on room thermostat Round.....	27
6.13	Factory settings, room thermostat.....	28
7	Connect the Round to internet via Gateway.....	29
7.1	Set-up account and download the app.....	29

Cetetherm Micro

Installation, service and operating instruction

7.2	Troubleshooting	30
7.3	Clearing binding between Round and the Gateway	31
8	Installing the room thermostat CM737	32
8.1	General	32
8.2	Choosing the operating mode	33
8.3	Temperature Enquiry with the Info-button (7)	33
8.4	Holiday function	34
8.5	OTC heating curve	34
8.6	Parallel adjustment of heating curve	34
8.7	Operating mode Auto	35
8.7.1	The Built-in Heating Program	35
8.7.2	Reviewing the Heating Program	35
8.7.3	Temperature Override	35
8.7.4	Disabling/enabling time periods	35
8.7.5	Modifying the heating program	36
9	Activation of installer parameters CM737	37
9.1	Entering the installer set-up mode	37
9.2	CM737–Category 1: Control panel settings	38
9.3	CM737-Category 2: ECO-functions	38
9.4	CM737-Category 3: Setting and displaying sensor values	39
9.5	CM737-Category 4: Heating actuator settings	39
9.6	CM737-Category 5: Fault History	39
10	Troubleshooting the CM737	40
10.1	Fault Codes on the CM737	41
11	Differential pressure control valve, DPC	42
11.1	Setting the DPC valve	42
11.2	Flow rate graph of the DPC	42
12	Pump settings and pump performance	43
12.1	Grundfos Alpha2L settings	43
12.2	Pump curve	44
13	Electrical circuit diagram	45
13.1	Micro RTC	45
13.2	Micro STC and Micro STC2	46
14	Service instructions	47
14.1	General service instructions	47
14.1.1	Tap water temperature too low	47
14.1.2	Tap water temperature too high	47
14.1.3	Hot water temperature unstable or too low	48
14.1.4	Heating system temperature too high or too low	48
14.1.5	No heating	48
14.1.6	Heating temperature unstable	48
14.2	STC service instructions	49
14.2.1	Heating system temperature too high or too low	49
14.2.2	No heating	49
14.2.3	Disturbing noise from the circulation pump/ Noise in the radiator system	50
14.2.4	Heating temperature unstable	50
14.3	HTC service instructions	50
14.3.1	Tap water temperature too low/ hot water temperature unstable or too low	50
14.3.2	Heating system temperature too high or too low	50
15	Service actions for the installer	51
15.1	Check the function of the valve for hot water	51
15.2	Check the function of the heating actuator and valve	52
15.3	Run the pump manually	52
16	Maintenance and repairs	53
16.1	Cleaning the heating media filter	53
16.2	Change the hot water actuator and heat exchanger	54
16.3	Change the hot water valve	54

16.4	Change the heating actuator.....	55
16.5	Change the heating valve.....	55
16.6	Change pump components or the complete pump.....	56
16.7	Change the heating circuit supply temperature sensor.....	56
16.8	Change the outdoor temperature sensor.....	56
16.9	Change the differential pressure control valve.....	57
16.10	Change the flow switch.....	57
17	Operating data and performance.....	58
17.1	Operating data.....	58
17.1.1	AquaMicro.....	58
17.1.2	Micro DPC, Micro RTC, Micro HTC, Micro STC, Micro STC2.....	58
17.2	Technical Data.....	59
17.3	Measure sketch.....	60
18	Options.....	61
18.1	Safety thermostat.....	61
18.2	Installing the safety thermostat.....	61
18.2.1	Parameters and recommended settings for under floor heating.....	61
18.3	First fix-jig.....	62

1 General information

Cetetherm Micro is a complete, ready-to-install heating network substation for hot water and heating. It is designed for buildings with a connection to a heating network. Cetetherm has years of experience in heating network technology and has developed Cetetherm Micro with well-planned pipe work and with all components easily accessible for inspection and possible future servicing.

1.1 Comfort

Cetetherm Micro has fully-automatic temperature control for heating and hot water. The hot water is controlled and maintained at the desired temperature. The heating is controlled in relation to desired room temperature.

1.2 Installation

Compact dimensions, light weight, well arranged plumbing and factory-complete internal wiring – all make installation very simple. A pre-programmed control unit and a power cable already fitted with a plug make things even simpler to allow immediate start-up.

Micro is designed for hanging on wall and is mounted on an insulated frame and includes an insulated cover. Better insulation means less energy usage and better energy efficiency.

1.3 Long-term security







The heat exchanger plates and all piping are manufactured in acid-resistant stainless steel. All components are closely matched and carefully tested for function in accordance with quality assurance system ISO9001:2015

For future servicing requirements, all components are easily accessible and individually replaceable.



1.4 CE-marking

Cetetherm Micro follows the rules and legislation specified in the Declaration of Conformity. To maintain the validity of the CE marking, only identical replacement parts must be used.

1.5 General warnings

	The installation work must be carried out by an authorized installation contractor. Before the system is taken into operation, it must be pressure tested in accordance with relevant regulations.
	The temperature and the pressure of the primary heating water are very high. Only qualified technicians can work with the substation. Incorrect operation may cause serious personal injury and result in damage to the building.
	If the hot water temperature is set too high, people may be scalded. If the hot water temperature is set too low, unwanted bacteriological growth may occur in the hot water system. This can result in serious personal injury.
	Parts of the substation may get very hot and should not be touched.
	When starting up the substation: To avoid the risk of scalding, make sure that no-one draws any hot water until the hot water temperature has been adjusted.
	Start heating circulation by first opening the valves in the primary heating supply and then return lines, to avoid pollutions in the system. Open the valves slowly to avoid pressure surges.

1.6 Micro STC and Micro STC2 warnings

	Before the substation is connected to the electrical supply, make sure that the heating system is topped up with water. Starting up the system without water will damage the circulation pump.
	The substation comes prepared with an electrical plug to be connected to the main supply. The strain relief clips of the cable must be fitted so that there is no risk of damage. If necessary, the plug-and-socket connection can be replaced with a permanent installation with an all-pole isolate switch. This must be carried out by a qualified electrician.
	Do not shut of the electrical supply to the room thermostat, this will damage the circulation pump, valves, actuators etc.

2 Operating instructions

2.1 General operation

The temperature and pressure of the incoming heating network water are very high. The heat from the heating network water is transferred to the heating and hot water systems of the building in the heat exchangers. The heat is transferred through thin plates of acid-resistant stainless steel which keep the heating network water separate from the systems in the building.

Micro has automatic temperature control for hot water. This measures the temperature of the hot water in the heat exchanger and automatically controls the primary flow.

The hot water temperature is controlled by a temperature control system which is set to about 50 °C. If the temperature is set too high, there is a risk of scalding. Setting the hot water temperature too low may result in unwanted bacteriological growth in the hot water system.

After adjustment, the Micro operates completely automatically. However, in hard water areas it is advisable to be attentive and to remedy any faults in good time if the temperature of the hot water is too high; otherwise the risk of lime deposits in the heat exchanger may increase.

The energy supplier registers the use of energy. Measurement is done by recording the flow of heating network medium through the system, and by measuring the temperature difference between the medium's supply and return flow.

2.2 Heating operation Micro STC and Micro STC2

With a Micro STC or a Micro STC 2, the heating circuit is controlled in relation to outdoor temperature (option) and/or desired room temperature by means of a room thermostat and temperature sensor. When no heat is needed, the circulation pump in the heating circuit stops automatically, but is started regularly to make sure that it does not seize up during long idle periods.

Micro STC2 has an extra heating connection that can be connected to radiators or towel heating.

2.3 Heating operation Micro RTC

With a Micro RTC, the heating circuit is controlled with a desired room temperature by means of a room thermostat. When the measured room temperature is too low according to desired room temperature, the relay box sends a signal to open the relay.

2.4 Safety equipment/inspection

- Daily inspection to check for leaks from pipes or components.
- Weekly inspection to make sure that the operation of the heating and hot water control systems is stable and that the temperature does not fluctuate. Temperature hunting causes unnecessary wear of valves, thermostats and heat exchangers.
- Every three months check the safety valves and the pressure in the heating system.

To check the operation of a safety valve, turn its wheel/knob until water escapes from the waste pipe of the valve, then close the wheel/knob quickly. Occasionally a safety valve may open automatically to release excess pressure. After a safety valve has been open it is important that it closes properly and does not drip.

3 Product overview

Note: The product overview pictures are shown without the insulation.

3.1 Product overview AquaMicro

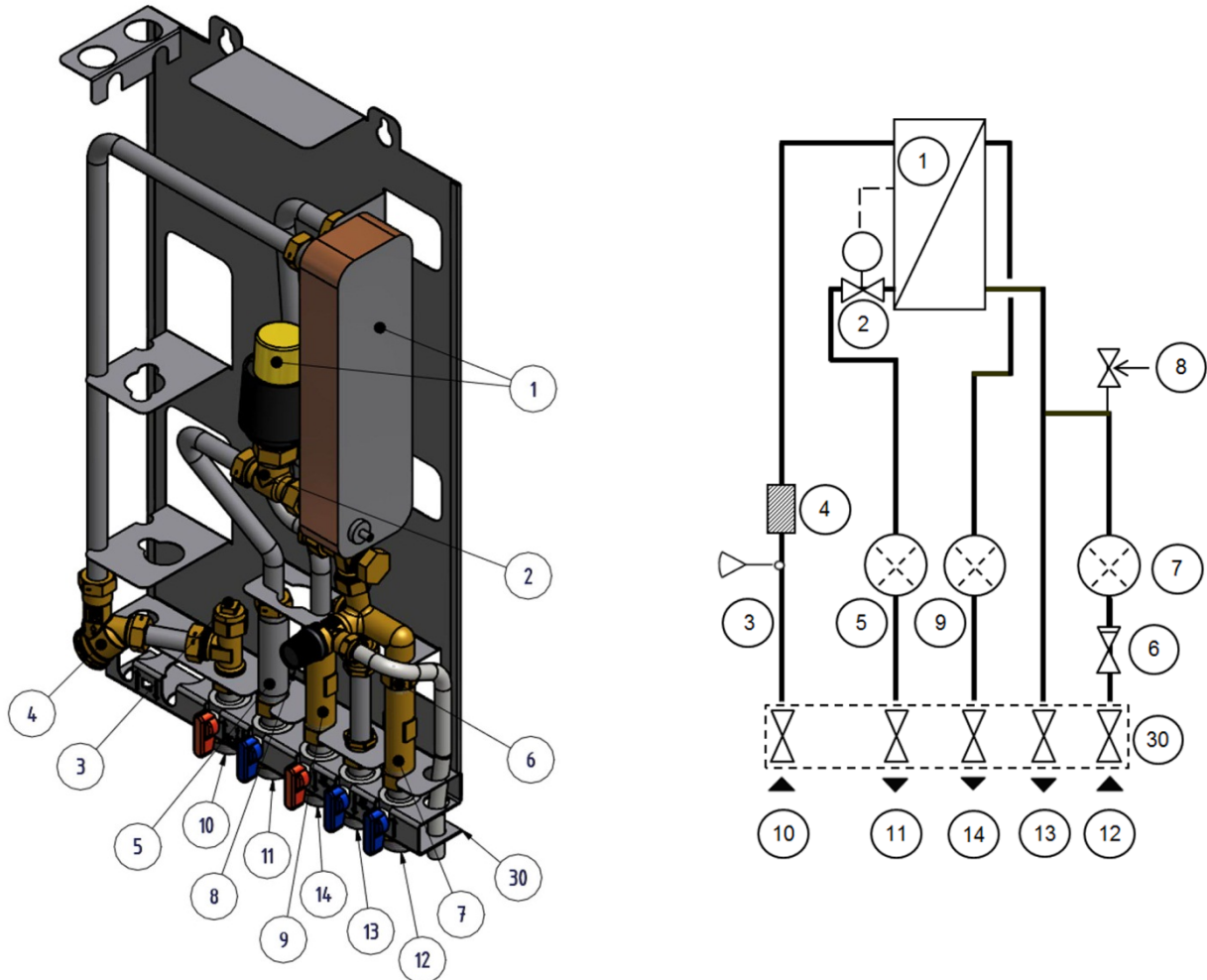

Picture 1

1	Heat exchanger and temperature controller for hot water	9	Adapter for Hot water flow meter
2	Control valve for hot water	10	Heating network media, supply
3	Temperature sensor connection, heating media supply	11	Heating network media, return
4	Filter for heating media	12	Cold water (cw)
5	Adapter for energy meter	13	Cold water outlet (cw)
6	Check valve for cold water	14	Hot water (hw)
7	Adapter for Cold water flow meter	30	First fix jig including shut-off valves (option)
8	Safety valve for domestic hot water		

3.2 Product overview Micro DPC

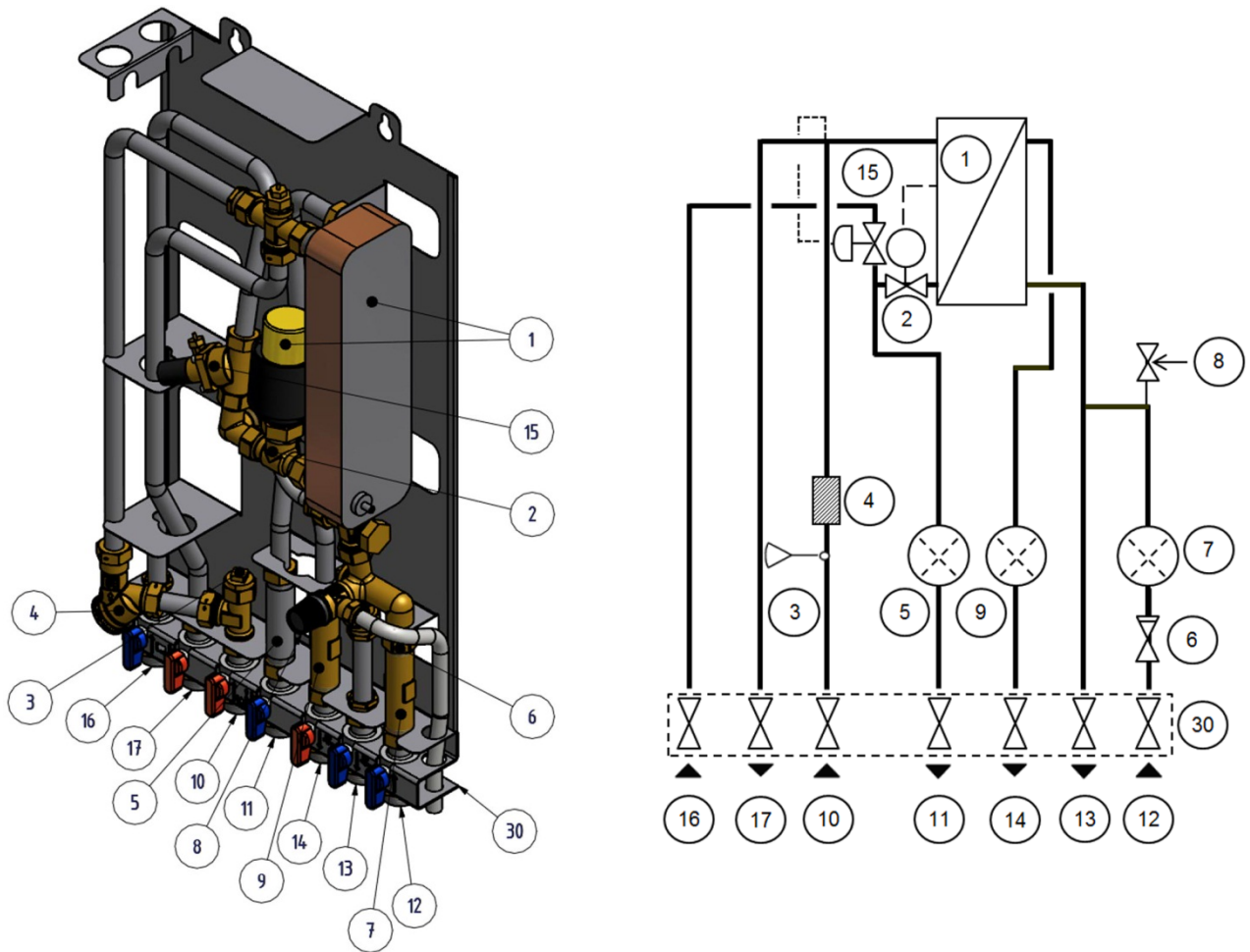

Picture 2

1	Heat exchanger and temperature controller for hot water	10	Heating network media, supply
2	Control valve for hot water	11	Heating network media, return
3	Temperature sensor connection, heating media supply	12	Cold water (cw)
4	Filter for heating media	13	Cold water outlet (cw)
5	Adapter for energy meter	14	Hot water (hw)
6	Check valve for cold water	15	Differential pressure controller
7	Adapter for Cold water flow meter	16	Heating circuit, return
8	Safety valve for domestic hot water *)	17	Heating circuit, supply
9	Adapter for Hot water flow meter	30	First fix jig including shut-off valves (option)

*) included depending on model

3.3 Product overview Micro RTC

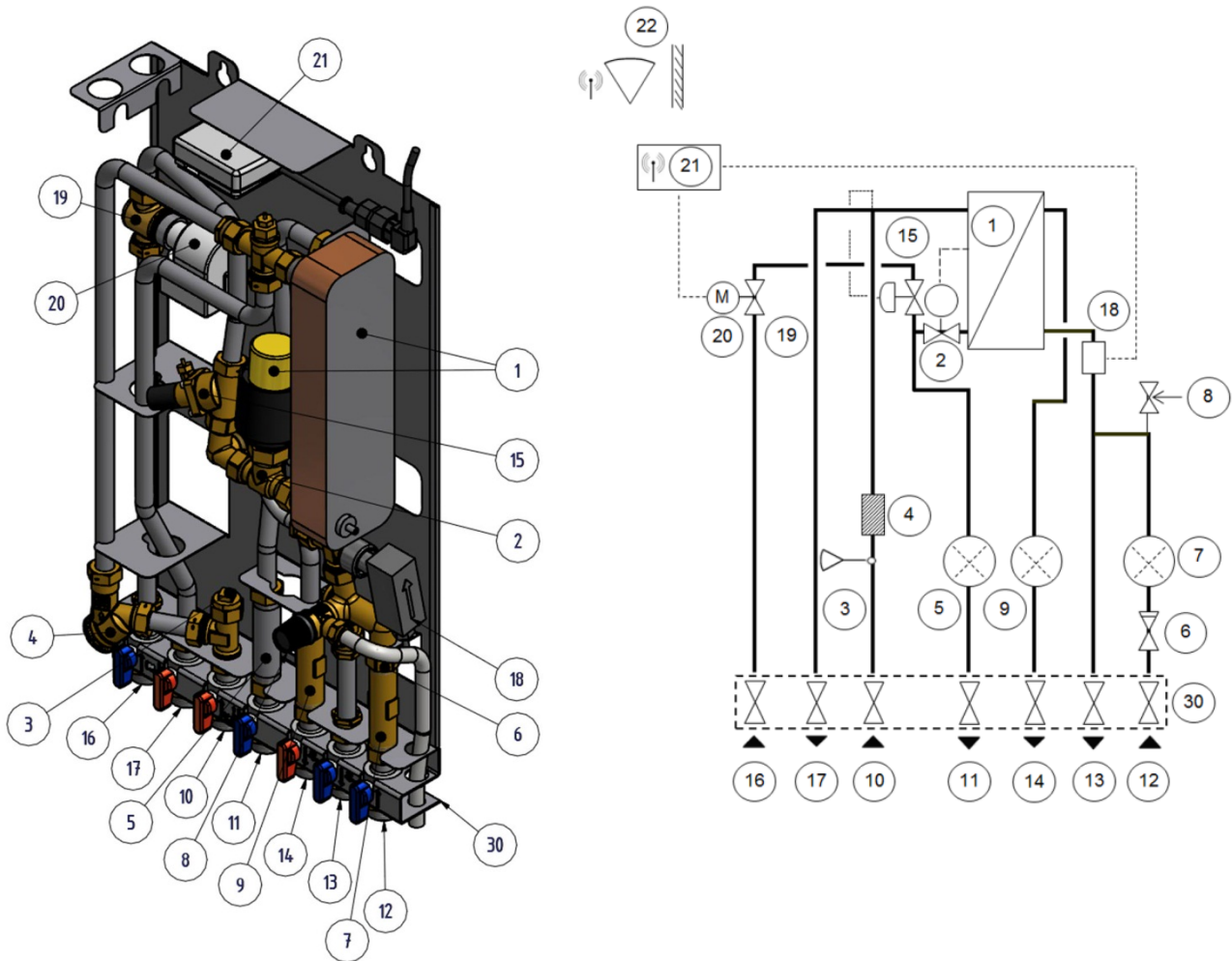

Picture 3

1	Heat exchanger and temperature controller for hot water
2	Control valve for hot water
3	Temperature sensor connection, heating media supply
4	Filter for heating media
5	Adapter for energy meter
6	Check valve for cold water
7	Adapter for Cold water flow meter
8	Safety valve for domestic hot water *)
9	Adapter for Hot water flow meter
10	Heating network media, supply
11	Heating network media, return
12	Cold water (cw)

13	Cold water outlet (cw)
14	Hot water (hw)
15	Differential pressure controller
16	Heating circuit, return
17	Heating circuit, supply
18	Flow switch for domestic hot water *)
19	Control valve, heating circuit
20	Actuator, heating circuit
21	Connection box for electric power and sensors, heating circuit
22	Room thermostat/control panel *)
30	First fix jig including shut-off valves (option)

*) included depending on model

3.4 Product overview Micro STC

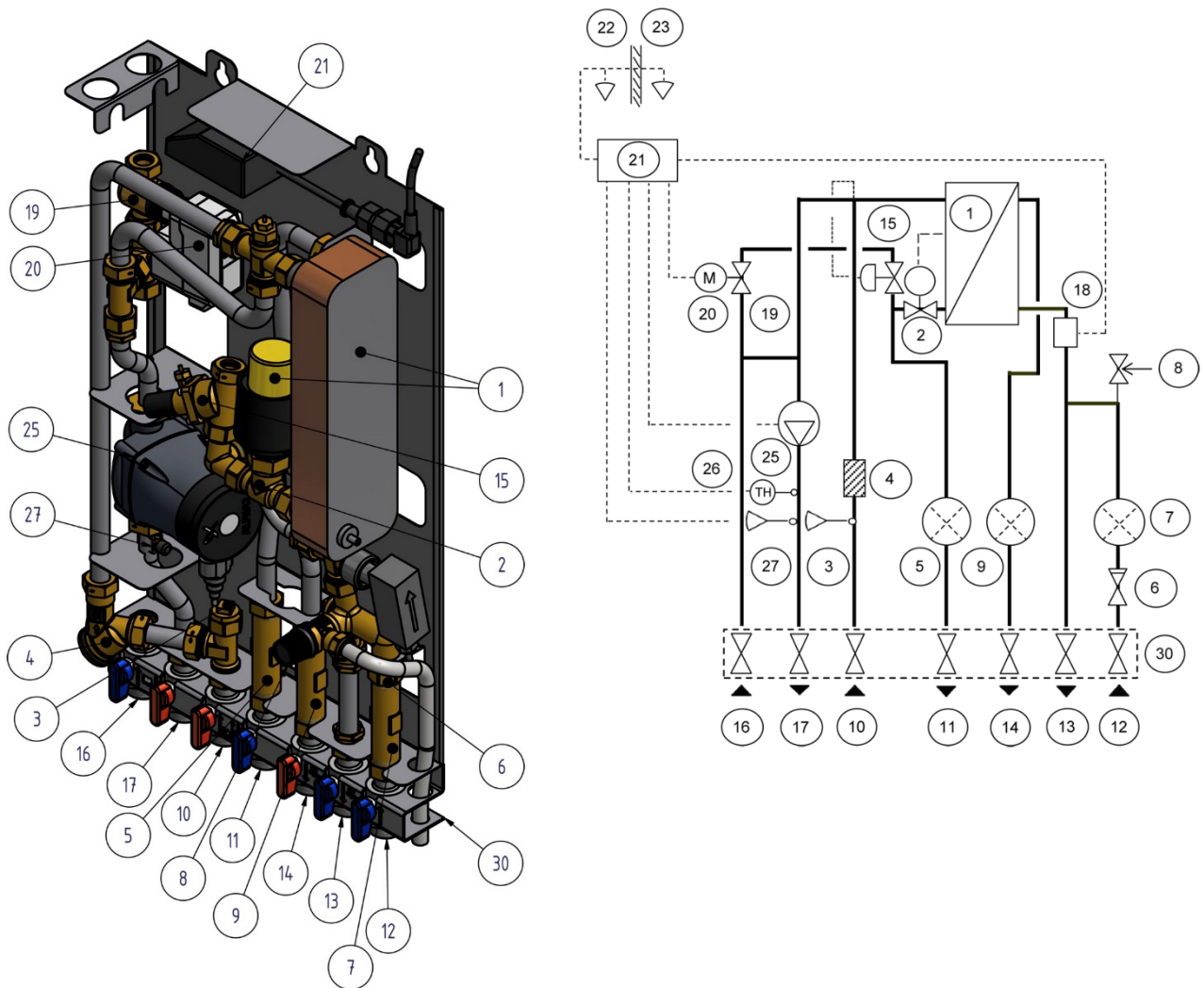

Picture 4

1	Heat exchanger and temperature controller for hot water
2	Control valve for hot water
3	Temperature sensor connection, heating media supply
4	Filter for heating media
5	Adapter for energy meter
6	Check valve for cold water
7	Adapter for Cold water flow meter
8	Safety valve for domestic hot water *)
9	Adapter for Hot water flow meter
10	Heating network media, supply
11	Heating network media, return
12	Cold water (cw)
13	Cold water outlet (cw)
14	Hot water (hw)

15	Differential pressure controller *)
16	Heating circuit, return
17	Heating circuit, supply
18	Flow switch for domestic hot water *)
19	Control valve, heating circuit
20	Actuator, heating circuit
21	Connection box for electric power and sensors, heating circuit
22	Room thermostat/control panel
23	Outdoor temperature sensor *)
25	Circulation pump, heating circuit
26	Safety thermostat (option)
27	Supply temperature sensor, heating circuit
30	First fix jig including shut-off valves (option)

*) included depending on model

3.5 Product overview Micro STC2

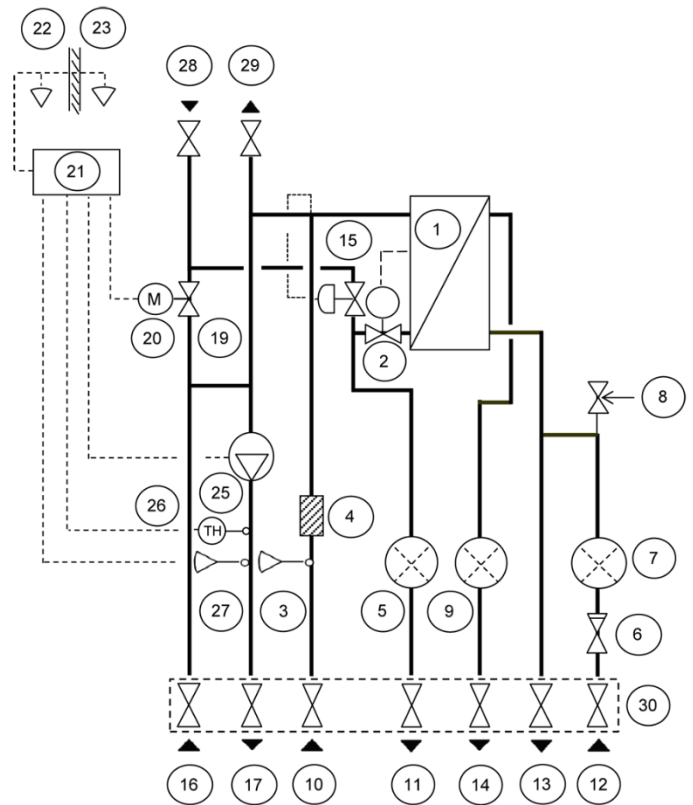
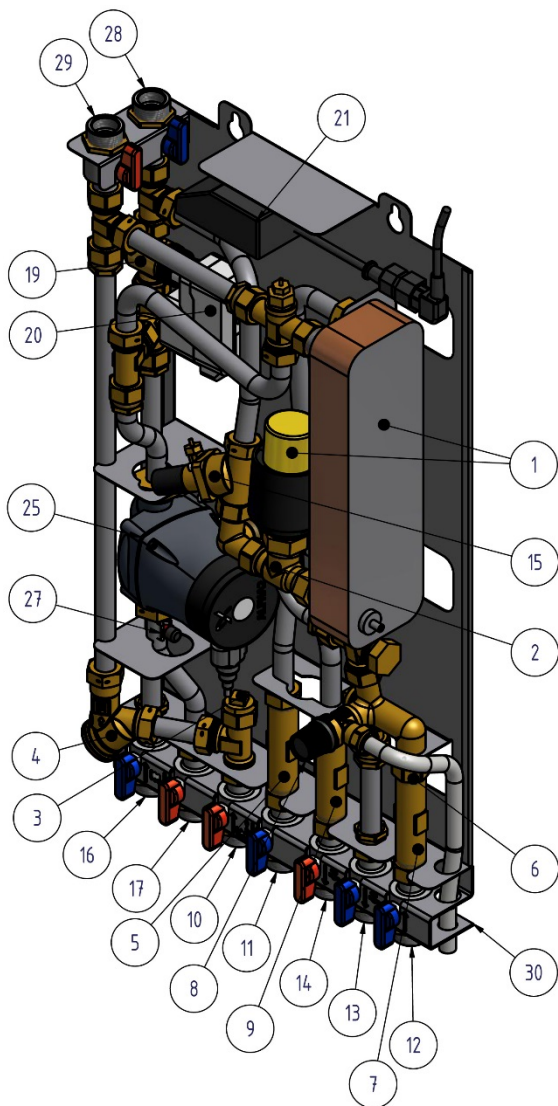

Picture 5

1	Heat exchanger and temperature controller for hot water
2	Control valve for hot water
3	Temperature sensor connection, heating media supply
4	Filter for heating media
5	Adapter for energy meter
6	Check valve for cold water
7	Adapter for Cold water flow meter
8	Safety valve for domestic hot water *)
9	Adapter for Hot water flow meter
10	Heating network media, supply
11	Heating network media, return
12	Cold water (cw)
13	Cold water outlet (cw)
14	Hot water (hw)

15	Differential pressure controller *)
16	Heating circuit, return
17	Heating circuit, supply
19	Control valve, heating circuit
20	Actuator, heating circuit
21	Connection box for electric power and sensors, heating circuit
22	Room thermostat/control panel
23	Outdoor temperature sensor
25	Circulation pump, heating circuit
26	Safety thermostat (option)
27	Supply temperature sensor, heating circuit
28	Heating circuit primary temp, return
29	Heating circuit primary temp, supply
30	First fix jig including shut-off valves (option)

*) included depending on model

3.6 Product overview Micro HTC

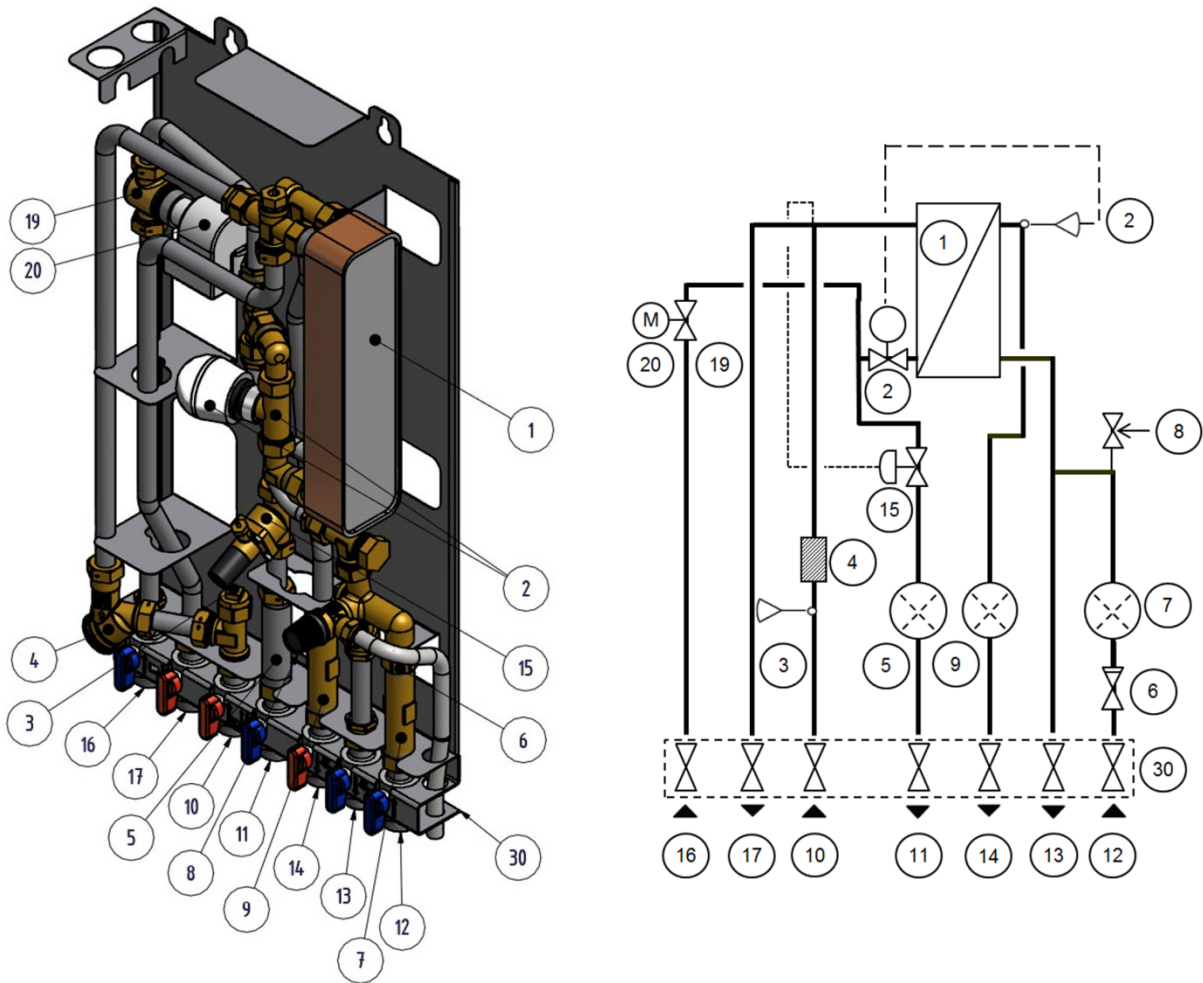

Picture 6

1	Heat exchanger and temperature controller for hot water	11	Heating network media, return
2	Control valve for hot water	12	Cold water (cw)
3	Temperature sensor connection, heating media supply	13	Cold water outlet (cw)
4	Filter for heating media	14	Hot water (hw)
5	Adapter for energy meter	15	Differential pressure controller
6	Check valve for cold water	16	Heating circuit, return
7	Adapter for Cold water flow meter	17	Heating circuit, supply
8	Safety valve for domestic hot water	19	Control valve, heating circuit
9	Adapter for Hot water flow meter	20	Actuator, heating circuit
10	Heating network media, supply	30	First fix jig including shut-off valves (option)

3.7 Symbols on the first fix-jig

The first fix-jig has symbols that show which supply and return pipe that should connect to the different connection points.

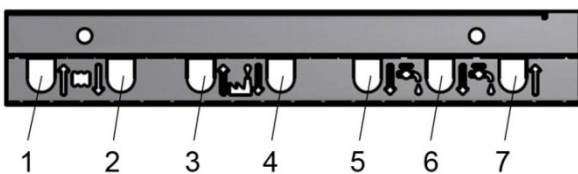

Picture 7

1	Heating circuit, return
2	Heating circuit, supply
3	Heating network media, supply
4	Heating network media, return
5	Hot water (hw)
6	Cold water outlet (cw)
7	Cold water (cw)

4 Installation

4.1 Unpacking

- Remove the transport packaging and check that the product has not been damaged in transit and that the consignment agrees with the specifications.
- When lifting the unit take care not to apply stress to pipes and heat exchanger as this may weaken them. Avoid lifting the unit by holding the heat exchanger.

Note: Risk of injury lifting heavy objects.

4.2 Preparation

- Choose a suitable installation area in accordance with official regulations. The system may generate sounds during operation caused by pumps, regulators systems, flows etc. This should be taken in consideration during installation of the unit so that possible operational sounds affect the surroundings as little as possible. This means that the system should be installed on well-insulated walls, such as outer walls or on concrete walls.
- Check the applicable regulations of the primary heating supplier. The available differential pressure should be for:
 - AquaMicro: at least 50kPa and at most 600 kPa
 - Micro DPC, RTC STC, STC2 and HTC at least 50 kPa and at most 400 kPa

Where the differential pressure is higher, a differential pressure controller should be added to the installation.

- Flush out the heating and hot water systems.
- Mount the first fix-jig (option) to the connection points. Tighten with 45 Nm.
- Carefully loosen the electrical plug from the insulation and attached it to the correct power cable. Make sure that the cable is fasten in the insulation

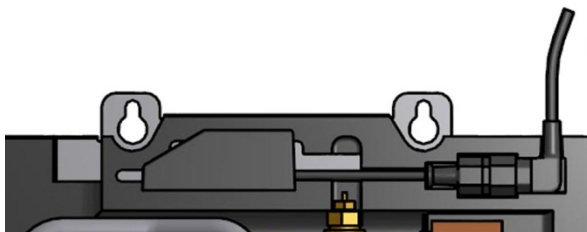

Picture 8

4.3 Mounting

- Mount the substation on the wall using four screws or bolts suitable for the material of the wall and for the weight of the unit. The unit may be mounted at any height on the wall, but 1500 – 1800 mm from floor to keyhole fixing may be taken as a guide. The hole pattern for screws/bolts and the piping connection measures is shown in [17.3 Measure sketch](#).
- Drainage pipe from the safety valve must be taken to floor gully.
- Energy meters must be installed at a prepared location, replacing a gauge block, or following the instructions of the energy supplier.
- Retighten all connections, including those made at the factory. Tighten with 45 Nm. If connections need retightening after the installation has been taken into service, the system should be depressurised before retightening. If the system is not depressurised before retightening, gaskets will be damaged.
- Connect the pipe work to the first fix-jig (option) connection points. Tighten with 45 Nm.

Cetetherm Micro

Installation, service and operating instruction

- Bleed the heating system.
Start the heating circulation pump with the highest output setting. Let the heating system heat up and bleed the system again.
- Set the pump capacity of the heating circulation pump according to the pressure head diagram.
Use the lowest setting that manages the heating demand for best electrical efficiency.

4.4 Mounting options general

- If the substation is connected to a system sensitive to high temperature or to a low temperature system, for example floor heating, a safety thermostat must be mounted and activated before start up. See 18.1.
For more information; contact the supplier of the under-floor heating system.

4.4.1 Mounting options Micro STC and Micro STC2

- Install the room thermostat.
 - Room thermostat Round: see 4.9 *Installing the room thermostat Round* or
 - Room thermostat CM737: see 4.10 *Installing the control panel CM737*.
- Mount the outdoor temperature sensor (option) on the north side of the building, 2 metres above the ground, or higher. See 4.11 *Installing the outdoor temperature sensor*

4.5 Adjustments and settings general

- Open up incoming cold water supply and fill the service water and heating circuits, bleeding off any trapped air.
- Check the operation and opening pressures of the safety valve.
- Adjust the hot water temperature by having a hot water tap open at normal flow rate for a time. Measure the temperature at the draw-off point with a thermometer. It takes about 20 seconds to get stable tap water temperature. The temperature should be approximately 50°C, this corresponds to a set point of approximately 1,5 on the actuator.
See chapter 14 *Service instructions* for adjusting hot water temperature.

Cetetherm recommends that the tap water temperature is set to 10° less than the primary inlet temperature.

NOTE: Make sure that no cold water is mixed with the hot water while making this adjustment.

- The property owner must be instructed in the operation, setting and care of the unit. It is particularly important to provide information about the safety systems and about hazards that may arise in relation to the high pressure and temperature of the primary heating water.

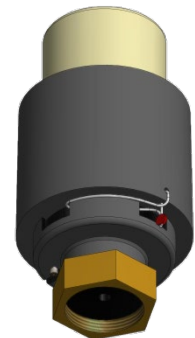

Picture 9

4.5.1 Adjustments and settings With a Micro HTC:

Recommended set point for the actuator is 5 or 6.

Set point	2	3	4	5	6	7
°C (approx.)	20	30	40	50	60	70

Cetetherm recommends that the tap water temperature is set to 15° less than the primary inlet temperature with a Micro HTC

NOTE: Make sure that no cold water is mixed with the hot water while making this adjustment.

- The property owner must be instructed in the operation, setting and care of the unit. It is particularly important to provide information about the safety systems and about hazards that may arise in relation to the high pressure and temperature of the primary heating water.

4.6 Commissioning advice Micro STC and Micro STC2

- Set the control mode on the control panel.
Control panel Round has been pre-set at the factory to use control mode; Outside Temperature Control (OTC control). To change control mode see [6 Room thermostat Round](#).

Control panel CM737 see [5 CM737- settings to be done after start-up](#).

The control panel has been pre-set at the factory to use Outdoor compensation (parameter 14:rC set to 1). To change see [5.1 Configure the control panel after installation](#).





4.7 Dismantlement

When the time comes for the substation to be dismantled and scrapped it must be disposed of in the correct manner in accordance with local or national regulations.

4.8 User instruction HTC hot water actuator

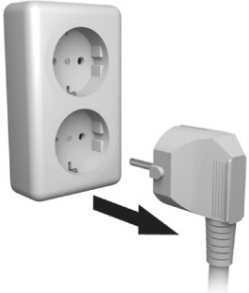
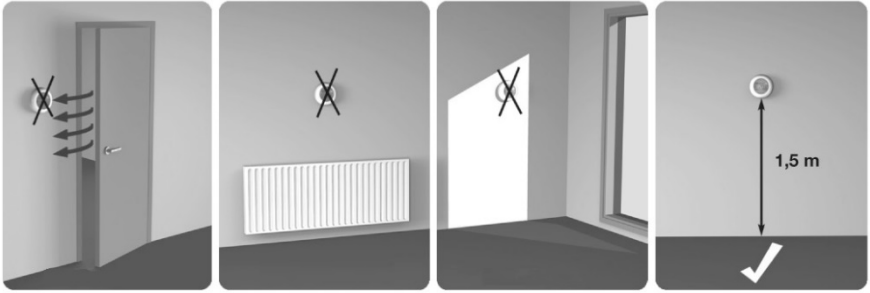
Hot water temperature in apartments or one family houses can be set to about 50°C. If the temperature is set too high, there is a risk of scalding. Setting the hot water temperature too low may result in unwanted bacteriological growth in the hot water system.

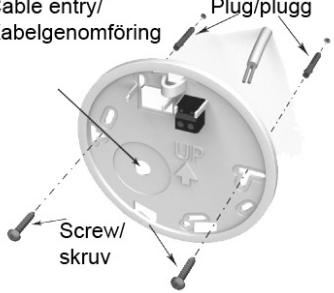
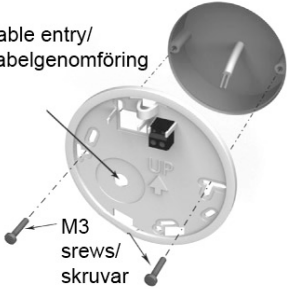
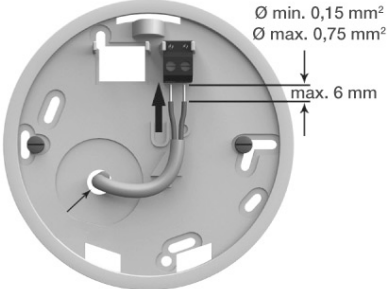
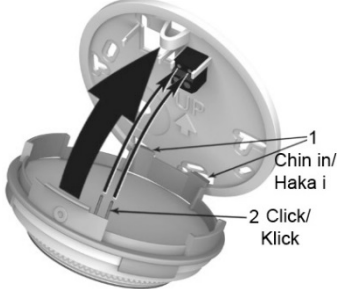
4.9 Installing the room thermostat Round

<p>1 Removing power supply</p> 	<p>2 Placement</p> 		
<p>3 Removing the dial</p> 	<p>4 Removing the thermostat</p> 	<p>5a Mounting direct on the wall</p>  <p>Cable entry/ Kabelgenomföring</p> <p>Plug/plugg</p> <p>Screw/ skruv</p>	
<p>5b Mounting in wall socket</p>  <p>Cable entry/ Kabelgenomföring</p> <p>M3 screws/ skruvar</p>	<p>6 Connecting the cable</p>  <p>Ø min. 0,15 mm² Ø max. 0,75 mm²</p> <p>max. 6 mm</p>	<p>7 Mounting the thermostat</p>  <p>1 Chin in/ Haka i</p> <p>2 Click/ Klick</p>	
<p>8 Mounting the dial</p> 	<p>Picture 10</p>		

4.10 Installing the control panel CM737

The control panel CM737 can be used as a room thermostat.
Before installation make sure that the electrical power supply is disconnected.
Install the room thermostat at an appropriate location that is representative to the indoor temperature.

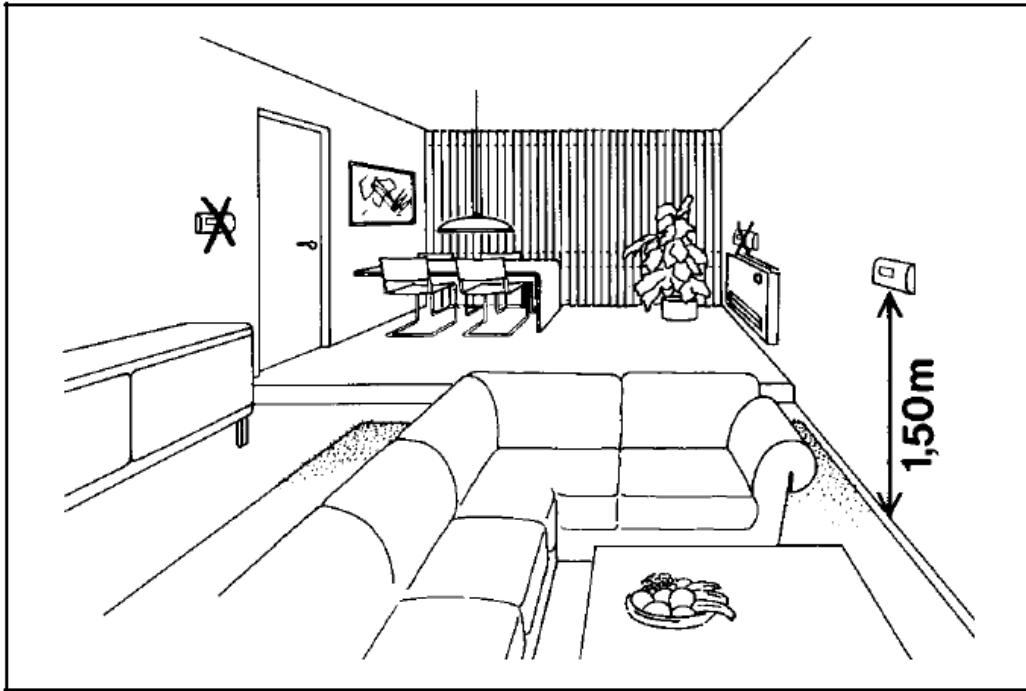

Picture 11

- A suitable installation is about 1.5 meters above floor and on an inner wall.
- The room thermostat must not be combined with other thermostats in the same control zone.

Use a suitable 2-conductor cable between the connection box and the operator control panel. With a conductor area of 0.6 mm², the maximum cable length is 50 metres. Maximum 5Ω/conductor. Install the cable ends in the terminal, marked A and B, located in the operator control panel. Connect the plug to the connection box again. The unit can now be connected to the electrical power.

After starting up, choose configuration and operating mode, see [5.1 Configure the control panel after installation](#).

Cetetherm Micro

Installation, service and operating instruction

1



SW Innan installationen av CM737, koppla bort matningsspänningen till reglercentralen.

ENG Before installing the CM737 disconnect the power supply to the heating appliance!

F Avant d'installer, l'alimentation du l'appareil de chauffage doit être coupé!

2

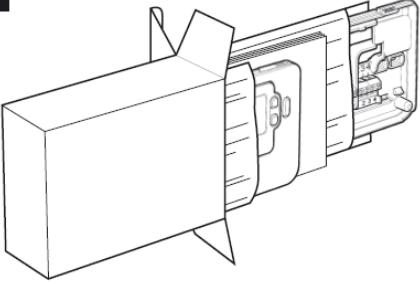

3

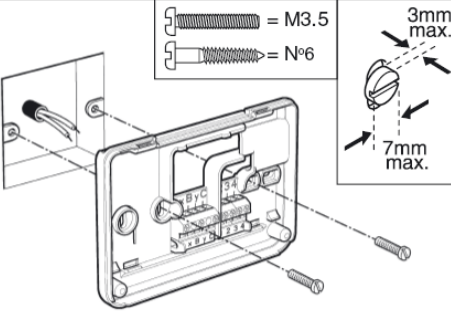

4

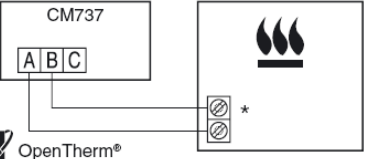

SW * Refererar till installationsanvisningen för reglercentralen.

ENG Refer to the installation manual for the heating appliance.

F Pour la numérotation exacte des bornes, référez vous aux instructions fournies avec votre chaudière.

5

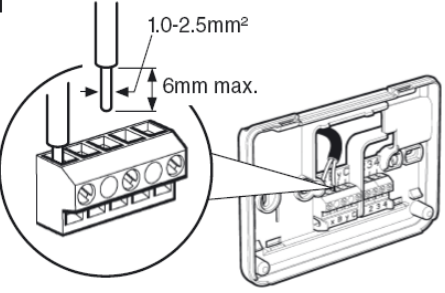

6

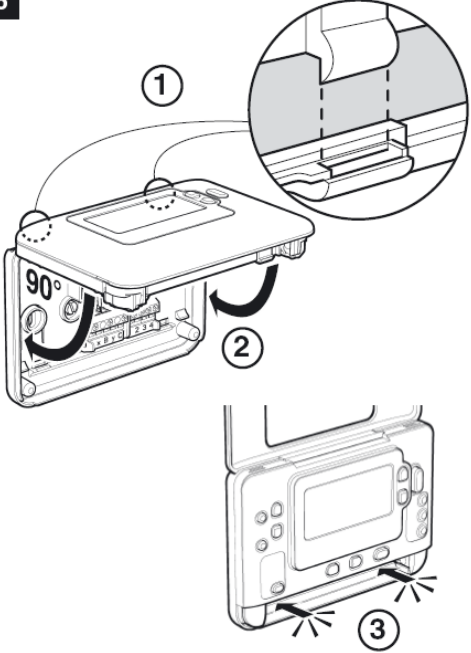

7

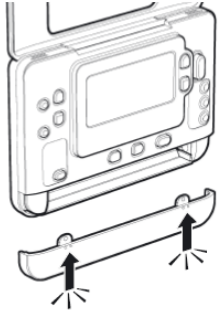

8

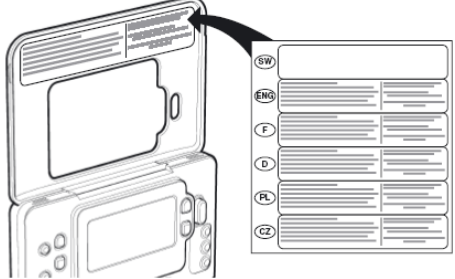

9

SW Koppla bort matningsspänningen till reglercentralen.

ENG Reconnect the power supply to the heating appliance.

F Rétablir l'alimentation sur l'appareil de chauffage.

Picture 12

4.11 Installing the outdoor temperature sensor

Connect the outdoor temperature sensor to the electric box.

With a conductor area of 0.6 mm² the maximum cable length is 50 metres, maximum 5Ω/conductor.

If the outdoor temperature sensor is connected later, for example in a construction period, the room thermostat must be restarted and configured.

Control panel Round: See [6.3 Changing control mode, OTC heating curve and max supply temperature](#).

Control panel CM737: Set parameter 14 according to requested compensation; see [5.1 Configure the control panel after installation](#).

4.12 Starting up sequence with component check



The substation must be filled with water before starting the room thermostat, if not the pump can be damaged.

- Put the electrical cable from the control panel into a wall outlet. We recommend using an earth fault breaker.
- A check of the actuator and pump function starts.
Check that the heating actuator knob turns and the pump function according to the following schedule:
 - 10s actuator closes – turns clockwise - if not already closed
 - 10s actuator opens - turns counter clockwise
 - 10s actuator closes – turns clockwise
 - 10s pump runs
 - 150s actuator closes.
- The next five minutes, the pump starts running and control begins to regulate to 37°C.

Note: Under certain operating conditions, 37°C is not reached within 5 min. The Actuator knob should however have moved counter clockwise.

When start-up sequence is completed the room thermostat returns to last set control mode.

Note: If there is no heat demand the pump stops after the start-up sequence.

5 CM737- settings to be done after start-up

1. Press the MAN (8) button for a fixed set point (no reduction) of the room temperature.
2. Adjust the room temperature with the increase/decrease buttons on the right (6).

By outdoor compensation this change represents a standard parallel shift of the heat curve, recalculated for room temperature. For more details see chapter [8.6 Parallel adjustment of heating curve](#).

5.1 Configure the control panel after installation

The room thermostat can be configured in three different ways. All installation parameters can be found in the parameter list, see [9 Activation of installer parameters CM737](#).

The control panel is pre-set to Outdoor compensation.

- Outdoor compensation OTC, require a connected outdoor temperature sensor, see [4.11 Installing the outdoor temperature sensor](#).
Set parameter 14:rC to 1.

Room compensation RTC, require a mounted room thermostat, see [4.10 Installing the control panel CM737](#).
Set parameter 14:rC to 0.
- Outdoor and room compensation OTC & RTC, require a connected outdoor temperature sensor and a mounted room thermostat see [4.11 Installing the outdoor temperature sensor](#) and [4.10 Installing the control panel CM737](#).
Set parameter 14:rC to 2.

5.2 Setting the day

1. Press the DAY button to begin setting the day, (1-7=mon-sun).
Each press will move the day indicator one step forward.
After 7 it will start over again at 1.
Press the green **OK** button to confirm

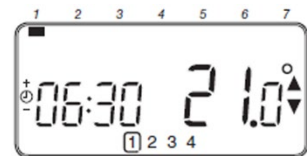

5.3 Setting the time

1. Press either of the **+** or **-** buttons once to enter timer setting mode. The LCD screen flashes the time digits. When the unit is powered for the first time the display shows 12:00.

2. Use the **+** or **-** buttons to set the correct time then press the green **OK** button to confirm.
Each press of the buttons will change the time by one minute and holding them down will change the time slowly at first and get progressively quicker.



6 Room thermostat Round

6.1 General

The room thermostat Round controls the supply temperature to the heating system.

First time the room thermostat is started is use default control mode Outside Temperature Control (OTC control).

The room thermostat is programmable and has five different control modes to select between.

Features

- Ergonomic user interface.
- A simple twist of the dial will adjust the temperature set point up or down.

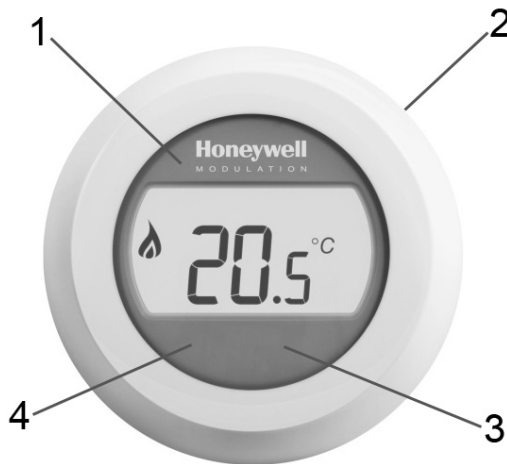

Picture 13

1	LCD display
2	Dial
3	Right touch button
4	Left touch button

Display (1)

The LCD has backlight; the backlight enables to read the data on the LCD in the dusk and dark. The backlight is switched off 10 seconds after last use.

In operating mode 2 (OTC control) the set room temperature is displayed in the window.

In operating mode 1 and 3 (RTC and RTC+OTC), the current room temperature is displayed by default in the window.

The thermostat measures the room temperature continuously in the room where it hangs.

Dial (2)

Turn the dial one "click" to see the setting of room temperature, if using control mode 1 and 3.

Turn the dial to change settings. Turn clockwise to increase and counter clockwise to decrease a setting.

Right touch button (3)

Use together with the left touch button to enter setting menu.

Left touch button (4)

Use together with the right touch button to enter setting menu.

Press to change parameter values and settings in different menus, change control mode, set max supply temperature, change heat curve slope.

Cetetherm Micro

Installation, service and operating instruction

6.2 Control modes

The room thermostat has five different control modes to select between; the default mode is Outside Temperature Control (OTC control).

- 1. Room temperature control RTC**
Supply setpoint is calculated based on the room temperature setpoint and the actual room temperature.
- 2. OTC control**
Require a connected outdoor temperature sensor.
Supply setpoint is purely based on the outside temperature.
- 3. OTC control with room temperature compensation (OTC+RTC)**
Require a connected outdoor temperature sensor.
Supply setpoint is based on the outside and room temperature.
- 4. Constant supply temperature (with closed contact)**
Select a fixed supply temperature setpoint. The heat is **on** when the contact (pos 1, [Picture 14](#)) is **closed**.
NOTE: Does not work with an outdoor thermostat connected.
- 5. Constant supply temperature (with open contact)**
Select a fixed supply temperature setpoint. The heat is **on** when the contact (pos 1, [Picture 14](#)) is **open**.
NOTE: Does not work with an outdoor thermostat connected.

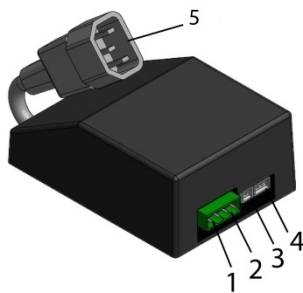

Picture 14

1	Universal input for connecting e.g. outdoor temperature sensor, flow switch, relay contact, strap
2	Room thermostat
3	Supply temperature sensor
4	Actuator, heating
5	Power cable adapter

6.3 Changing control mode, OTC heating curve and max supply temperature

Three different settings can be done:

- Control mode (1-5)
 - Heating curve (4-40)
 - Max supply temperature (30°-80°C)
-
- Turn the dial down to 10°C. The display starts to flash.
 - While the display is flashing it is possible to enter the setting menu by pressing both right and left touch button for 10 seconds.
 - Use the dial to choose control mode, 1-5.
Confirm the choice within 10 secs by pressing the left touch button.
 - Choose the heating curve with the dial, 4-40.
Confirm the choice within 10 secs by pressing the left touch button.
 - Choose max supply temperature with the dial, 30°-80°C.
Confirm the choice within 10 secs by pressing the left touch button.
 - When all settings are done wait a few seconds and the room thermostat automatically leaves the setting menu in 10 seconds.
 - After changing the control mode, wait at least 30 seconds and then restart the room thermostat. This is to ensure correct function.

6.4 OTC control mode, default setting

The room thermostat controls the indoor temperature as a function of the measured outside air temperature.

The heat curve is the ratio between the measured outside air temperature and the calculated supply water temperature.

The ideal heating curve is dependent on the type of installation (radiators, convectors, etc.), the thermal properties and the location of the property.

A heating curve ratio of 1 to 40 can be set. The figure shows several heating curve ratios for a room temperature setting of the 20°C **without** room temperature compensation.

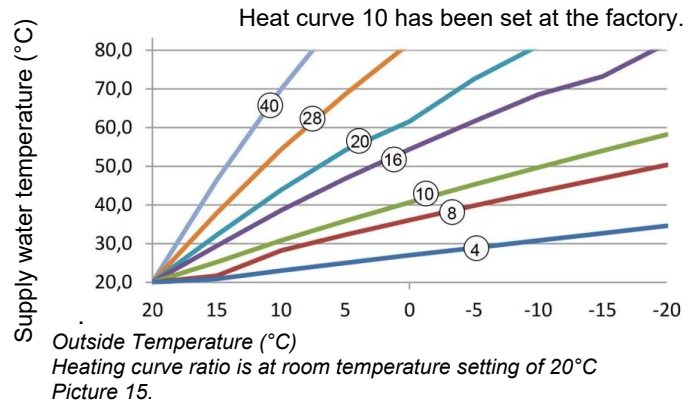

6.5 Viewing the room temperature

Note: Only valid with control mode 1-3.

The room temperature is displayed by default. The thermostat measures the room temperature continuously in the room where it hangs.

6.6 Viewing the set room temperature

Note: Only valid with control mode 1-3.

The set temperature is the desired temperature in the room where the thermostat is located.

Check the set temperature; by rotating the dial ring one way or tactile click clockwise.

The set temperature will flash.

After five secs, the display returns to show the room temperature.

Note: During commissioning, the standard set temperature is 17 °C.

After power failure, the last set temperature will always be active.

6.7 Changing temperature setting

Change the temperature setting by rotating the dial ring. With each click counter-clockwise decreases the set temperature with half a degree. Each click clockwise increases the temperature by half a degree.

During setting the temperature is flashing. At the desired temperature, allows the ring loose.

After five seconds, the display will show the actual room temperature or the set supply temperature, depending on set control mode.

If using control mode 1-3 the thermostat will adjust the room temperature as closely as possible to the newly set temperature.

6.8 Setback

In the absence and at night the thermostat can manually be set at a lower temperature to save energy.

In general, it is recommended a reduction of up to 5 ° C. Under the influence of the warm-up capacity of the plant and the degree of isolation of the property may be desired another temperature drop.

6.9 Summer heating

The pump should stop within 300 seconds if measured outdoor temperature is higher than the pre-set temperature *Outside Limit* (20°C).

6.10 Display symbols







Control mode	Display will show		
1 RTC			Shows the actual room temperature with one decimal and in 0.5 steps when the room temperature is used.
2 OTC			Shows the room temperature setpoint with one decimal and in 0.5 steps when temperature control mode is OTC.
3 RTC+OTC			Shows the actual room temperature with one decimal and in 0.5 steps when the room temperature is used.
4 Constant supply temperature with closed contact			Shows the requested supply temperature when the room temperature is not used.
5 Constant supply temperature with open contact			Shows the requested supply temperature when the room temperature is not used.

	Heating on Means there is a requirement for some heating
	SummerHeating is active
	There is an ongoing alarm
	Connected to Gateway

6.11 Fault messages on the room thermostat

If a spanner  is visible on the display there is an ongoing alarm.

On the display	Cause
	Fault code is shown on 7-segments
	Internal fault (like sensor fault)
	There is no (valid) outside temperature
	Room thermostat not connected to a correct connection box

6.12 Fault codes on room thermostat Round

Fault code 0	No fault, power up
Fault code 1	Supply sensor or cable
Cause	Measured supply water temperature is below 0°C or above 100°C.
Actions	The control panel turn the pump off and enter off mode (frost protection). Check the supply sensor and its cable.
Fault code 2	Outside sensor out of operating range. This fault code can only occur after the measured outside temperature has been in range: -40°C to 60°C.
Cause	Measured outside temperature is below -40°C or above 60°C
Actions	Enter room compensation until a valid temperature has been measured. Check the outside sensor and its cable.
Fault code 3	Connection box temperature out of operating range
Cause	Measured environment temperature is below -0°C or above 60°C.
Actions	The control panel turn the pump off and enter off mode (frost protection). Make sure that the substation is mounted in a well vented room.
Fault code 4	Cannot reach the set supply water temperature
Cause	Air in the pump, low temp/ not district heating supply.
Actions	Vent the pump, check the control valve and actuator.
Fault code 7	No communication between control panel and connection box
Cause	The connection box does not communicate with the control panel (by OT) for 60 seconds.
Actions	Fault is only cleared after a power break and OT communication is working again. Check the control panel cable.
Fault code 8	Outside sensor detected and heat demand input configured.
Cause	Outside sensor detected and heat demand input configured
Actions	Heat demand input doesn't work

Cetetherm Micro

Installation, service and operating instruction

6.13 Factory settings, room thermostat

Setting/function	Default Value	Setting/function	Default Value
Control mode	OTC	Min Room setpoint	10.0 °C
Room Temp Setpoint	17.0 °C	Max Room setpoint	27.0 °C
Constant Supply Temp Setpoint	40 °C	Min Supply setpoint	0 °C
OTC Ratio	10	Max Supply setpoint	60 °C
Setpoint lock	unlocked	Outside Limit (summer heating)	20 °C

7 Connect the Round to internet via Gateway

1. Connect the Gateway to power



LED status on Gateway

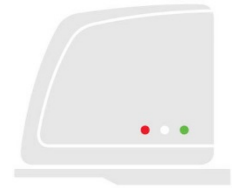

2. Connect the Gateway to internet router



3. Bind the Gateway to room thermostat Round

Put Gateway into BIND mode by pressing BIND button on base, for 1 second.

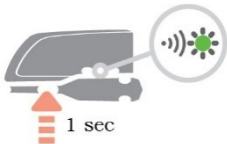

Put Round into BIND mode by pressing the right touch-button under the display for 10 seconds.

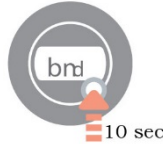

Send BIND signal from Round by pressing once again on the right touch button.

LED on Gateway should turn solid green (= good signal).



Round will display binding confirmation + signal strength (5 = good signal) for a few seconds before returning to normal operation.



7.1 Set-up account and download the app

Visit www.mytotalconnectcomfort.com to create an account and register the Gateway.

NOTE! The mail with the activation information might end up in your Junk mailbox.

Chose Comfort system.
You will need the MAC ID and CRC which can be found on the base of the Gateway.

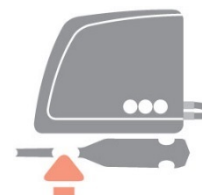

Cetetherm Micro
 Installation, service and operating instruction

LED on Gateway should turn solid green when successfully registered.

Download the free app *Total Connect Comfort Europé*.

Choose "Create account".

Fill in all fields.





A conformation mail is send to the mail address.

NOTE! The mail with the activation information might end up in your Junk mailbox.

Click on the link in the mail and login with your mail and password.
 Logon to the app to see all connected devices.

NOTE! If the heating has been turned off from the app it must be turned on from the app.

7.2 Troubleshooting

	Lost communication with the Round	Check that Round is powered and within RF range
	No internet connection	Check that the home internet router can access the internet
	Trying to connect to home internet router	If LED stays orange, check cables and power to home router.
	Not yet registered	Set up account on www.mytotalconnectcomfort.com

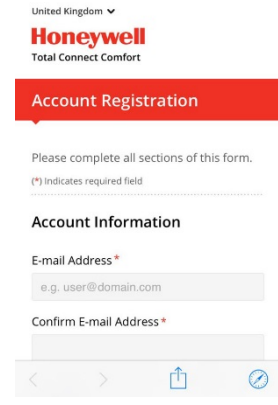
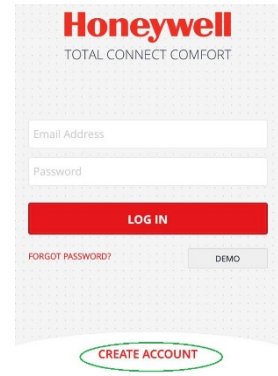

7.3 Clearing binding between Round and the Gateway

If Round needs to be replaced the binding must be cleared from the Gateway first. As the heating schedule is stored by the Gateway (and not by the App) it will be cleared and need to be set up again.

1. Clear Gateway binding by pressing BIND button on base for 5 seconds (LED will flash during).

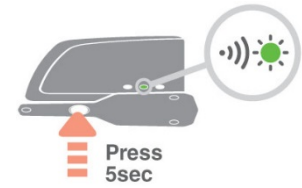

2. LED turns OFF on Gateway and Gateway icon disappear on Round, indicating that binding has been cleared.



8 Installing the room thermostat CM737

8.1 General

CM737 controls the supply temperature to the heating system. When connecting the unit to the power supply, CM737 verifies the connected sensors and then automatically chooses to control by room or outdoor temperature sensor or both.

Features

- Ergonomic user interface
- Large LCD (Liquid Crystal Display) Screen
- Four independent temperature levels per day, from 5°C to 35°C
- Built-in Memory holds the user program indefinitely
- Holiday button saves energy by letting you reduce the temperature for 1 to 99 days
- 7- days heating program to match your lifestyle, and maximising energy savings

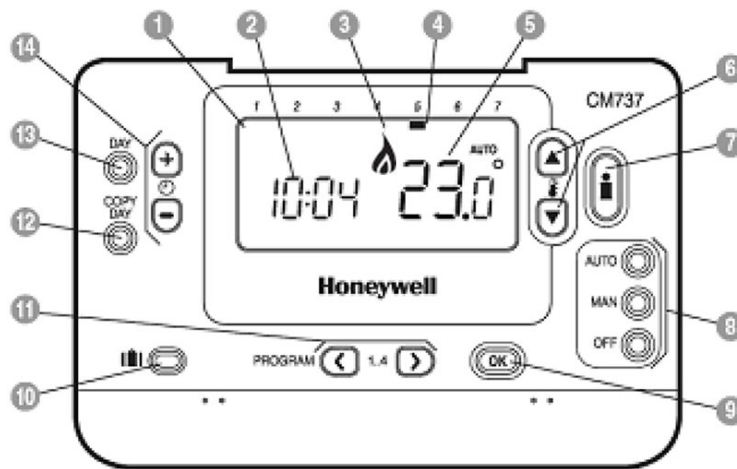

Picture 16

1 LCD display	6 Temperature change buttons	11 Program buttons
2 Time display	7 Temperature enquiry button	12 Copy day button
3 Heating indicator	8 Operating mode buttons	13 Day select button
4 Day indicator	9 OK button, green	14 Time change buttons
5 Temperature display	10 Holiday function button	

Micro STC and Micro STC2 with CM737 are supplied fully wired. The wiring conforms to the applicable rules for CE marking and has undergone electrical safety tests testing and function tests.

OK-button (9)



When changing settings/values in CM737 the numbers in the display is flashing. Confirm the new settings with the green OK-button (9) and the new setting will be confirmed.

8.2 Choosing the operating mode

The room thermostat can operate in three different modes; Automatic, Manual or Off.

To set the operating mode press either of the **AUTO**, **MAN** or **OFF** buttons. The screen indicates which mode is currently active.

NOTE: Cetetherm recommends the mode **MAN**.

- **MAN (fixed)** the room thermostat acts with a fixed set point throughout the day.
The set point can be adjusted from 5 °C to 35 °C by using the  or  buttons.
The thermostat will continue to maintain this temperature until another operating mode or temperature is selected.
- **AUTO (automatic)** the room thermostat follows the built-in temperature program, default or modified.
A manually adjustment of the temperature with arrow “up” or “down” is only valid until next programmed temperature change.
NOTE: The built-in heating program has been designed to provide normal comfort requirements, but to customise the settings please see [8.7 Operating mode Auto](#).
- **OFF** the room thermostat controls to a minimum temperature. Default setting of 5 °C acts as a frost protection to your home.

8.3 Temperature Enquiry with the Info-button (7)

Each value will be displayed for 3 second before returning to show the initial screen.

NOTE! The initial screen shows different temperatures depending on if the outdoor temperature sensor is connected and the setting of parameter 14:rC in the room thermostat.

- Target room temperature - with outdoor compensation.
- Current room temperature – with room compensation.

Press once on the info-button , the display will show one of following three:

1. **EXT above the clock and a temperature.**

The outdoor temperature sensor is installed correct and the controls the heating.

Displayed temperature is present outside temperature, according to the sensor.

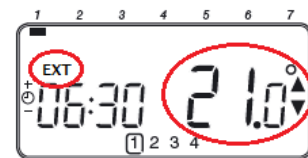

Press once more on the **Info**-button, in 3 seconds, to show the supply temperature. Check that the temperature is reasonable buy carefully touching the supply pipe.

2. **Flashing temperature and no EXT above the clock.**

The temperature flashing is the set point according to room compensation and the room thermostat controls the heating without the outdoor temperature sensor.

Press once more on the Info-button, within 3 seconds, to see the value of the outdoor sensor.

3. **EXT above the clock and ---- instead of the outdoor temperature.**

This means that the outdoor sensor or its cable is damaged or not connected.

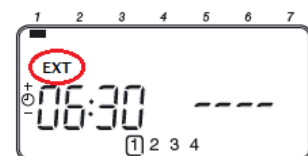









Press once more on the **Info**-button, in 3 seconds, to show the supply temperature. Check that the temperature is reasonable buy carefully touching the supply pipe.

8.4 Holiday function

The holiday function allows you to set a constant temperature (default = 10 °C) for a specified number of days (from 1 - 99 days). This saves energy and related costs when the house is empty but resumes normal operation on the day of return.

To set the Holiday function:

1. Ensure the room thermostat is running in **AUTO** or **MAN** operating modes.
2. Press the holiday  button to display the holiday day's counter and temperature setting, along with the holiday indicator .
3. Press the   or  time buttons to set the holiday time (1-99 days) and press the green  button to confirm.
4. Press the  or  buttons to set the holiday temperature (5 °C – 35 °C) and press the green  button to confirm.

The room thermostat will now control to the new temperature for the set number of days that the home is vacant. At midnight, the holiday counter will be reduced by one until the selected number of days have passed. The room thermostat will then return to former operation as set by the **MAN** or **AUTO** mode.

To cancel the HOLIDAY function or to exit the function at any time: press the  button a second time.

8.5 OTC heating curve

The CM737 controls the indoor temperature as a function of the measured outside air temperature. The heating curve is the ratio between the measured outside air temperature and the calculated supply water temperature.

The ideal heating curve is dependent on the type of installation (radiators, convectors, etc.), the thermal properties and the location of the property. A heating curve ratio of 1 to 40 can be set. The figure shows several heating curve ratios for a room temperature setting of the 20 °C **without** room temperature compensation.

8.6 Parallel adjustment of heating curve

If any other room temperature set point than 20 °C is used the selected curve will be parallel compensated.

Every change of the room temperature set point from 20 °C will change the supply temperature with approximately 3 °C. If the room temperature set point is increased from 20 °C to 21 °C the supply temperature will increase with approximately 3 °C.

This example shows parallels of curve 10 by 19 °C and 21 °C.

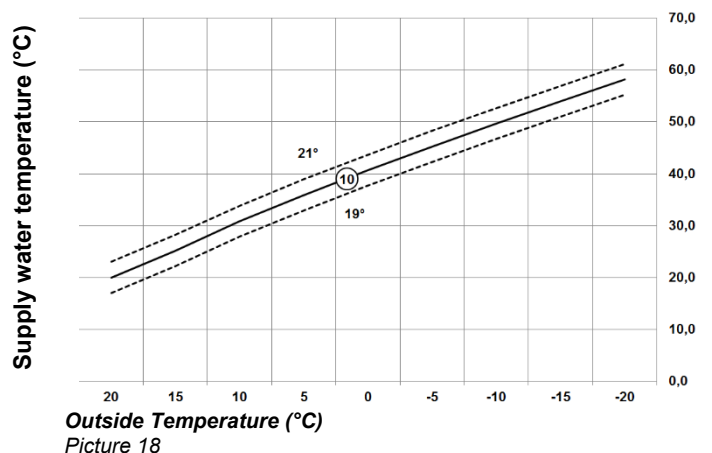
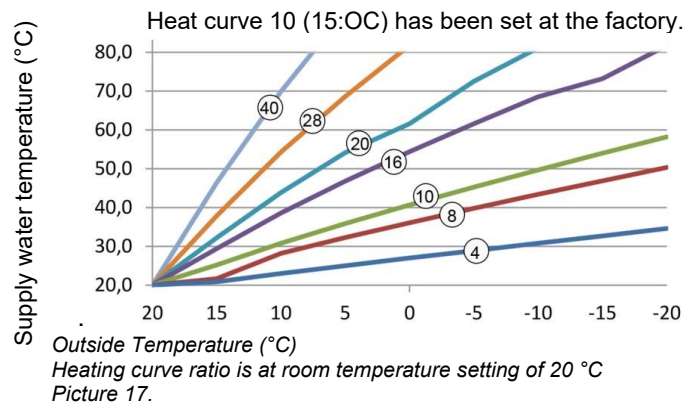

8.7 Operating mode Auto

8.7.1 The Built-in Heating Program

The built-in heating program has four temperature level changes per day that can be set between 3.00am and 2.50am the following day - allowing the evening temperature to maintain after midnight. Each temperature level can be set between 5 °C and 35 °C, and adjusted in 0.5 °C increments.

The factory default program for heating is as:

Monday to Friday (Day 1 to 5)

Period	1	2	3	4
Time	6:30	8:00	18:00	22:30
Temperature	21 °C	18 °C	21 °C	16 °C

Saturday & Sunday (Day 6 & 7)



Period	1	2	3	4
Time	6:30	8:00	18:00	22:30
Temperature	21 °C	18 °C	21 °C	16 °C

8.7.2 Reviewing the Heating Program

To review or edit the heating program use the **PROGRAM**  or  buttons to navigate between the four individual programming periods.

Use the **DAY** button to step through each day of the week, so the complete 7-day heating program can be reviewed or edited.

8.7.3 Temperature Override





During **AUTO** mode, the programmed temperature can be adjusted manually. The 'target' temperature will be displayed and flash for 5 seconds - during this time the  or  buttons can be used to modify the set value.

NOTE: This temperature override is cancelled at the next programmed temperature change.

8.7.4 Disabling/enabling time periods

Any of the heating period from 2 to 4 can be removed from (or returned to) the heating program profile.

To disable or enable time periods:

- To disable unwanted periods, go to the desired period (2 to 4) using the **PROGRAM**  or  buttons to navigate, ensure the correct period is highlighted with the flashing square symbol. Press and hold the  button for at least 2 seconds and the display will indicate the period has been removed from the program.
- To enable periods again, follow the same procedure as above, navigating to the already disabled period. To enable this period again, press and hold the  button for at least 2 seconds.

Cetetherm Micro

Installation, service and operating instruction



8.7.5 Modifying the heating program

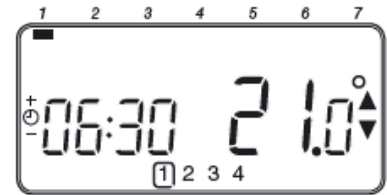

To change the heating program:

- a) Press either of the **PROGRAM**  or  buttons to enter the programming mode.

The time /temperature settings for period  on Monday day 1 will be flashing. The active period is highlighted by a flashing square around the numbers at the bottom of the screen and the selected day is shown with the day indicator.







- b) To adjust the period, start time use the   or  buttons, the 'OK?' indicator will be displayed to confirm the change. Holding the button down will change the time quickly.



Note: If you are pressing the   or  buttons and the display flashes the next period, it means the next period will be pushed forward.

- c) Once the required time is reached press the green  button to confirm.

Note: If the original time setting did not require adjustment press the green  button to move to step 'd'.

- d) The temperature setting for period  on Monday (Day 1) will now be flashing. To adjust this, press the  or  buttons and confirm the setting again by pressing the green  button.
- e) The next time and temperature period will now be active. Adjust this by repeating steps b - d above until all four periods are set or press the **AUTO** button to run the program as set, at any time.

Chose how to set the program for the next day:

- f) Press the **COPY DAY** button to copy Monday's program into Tuesday. The display will go blank apart from the 'non-flashing' day indicator, which indicates the day copied and the 'flashing' target day to copy the program to. To accept this day, press the green  button. To select a different target day press the **DAY** button until the 'flashing' day indicator is under the required day, and then accept it by pressing the green  button.

Note: Once the target day is confirmed it becomes the day that is copied if the **COPY DAY** button is pressed again.

Or

Press the **DAY** button to move the day indicator to Tuesday (Day 2). The program for that day can then be adjusted by following steps **b** to **e**. Programs for the remaining days can be set in the same way, using the **DAY** button to move to the next day.

To exit the programming mode, select the desired operating mode by pressing the **AUTO**, **MAN** or **OFF** buttons.

Note: To run the adjusted program; select the **AUTO** mode.

9 Activation of installer parameters CM737

Installer Mode is used to alter the system settings for specific applications, to use the special features of the room thermostat in a different way or to alter the factory present parameters. Parameters are divided into groups:

- Category 1 Control panel/Room Thermostat Setup
- Category 2 Eco-functions/ System Setup.
- Category 3 Settings and displaying sensor values
- Category 4 Heating actuator settings
- Category 5 Fault History

9.1 Entering the installer set-up mode

- Press the **OFF** button.
- Press and hold the **i** button and the two **PROGRAM** **<** and **>** buttons together.
- The unit will display the first parameter of installer parameter group category 1.
- Press the **▲** or **▼** button to change the factory setting.
The display will flash indicating that a change has been made.
- Press the green **OK** button to confirm the change. The display will stop flashing.
- Press the **⌚** **+** button to go to the next parameter.
- Press the **PROGRAM** **>** button to go to the next parameter category.
- To exit installer mode, press the **AUTO**, **MAN** or **OFF** button.

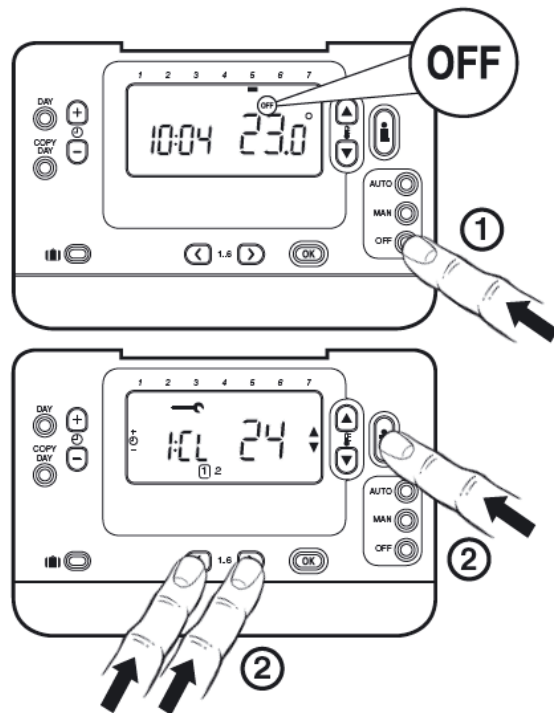

Picture 19

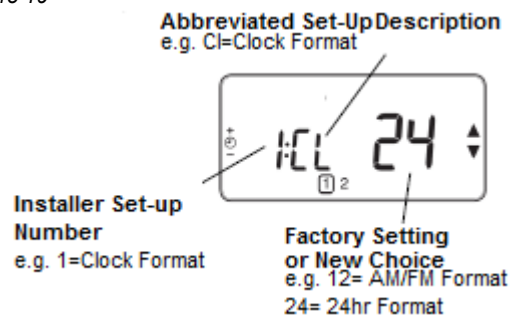

Picture 20

9.2 CM737–Category 1: Control panel settings

Parameter	Parameter N:o	Factory Default Setting	Optional Setting	
			Display	Description
AM-PM / 24hr Display	1:CL	24	24/12	24hr. or AM/PM clock display format
Reset Time/ Temp Program (Only used in Auto mode)	2:rP	1	1/0	0: time or temp has been changed 1: Time / Temperature according to factory setting Set 1 To restore the factory setting
Upper room Temp Limit	6:uL	35	21 to 35	Upper room Temp Limit
Lower room Temp Limit /freeze protection temp	7:LL	5	5 to 21	Lower room Temp Limit /freeze protection temp
Room Temperature Offset	12:tO	0	-3 to +3	adjustment room temp display
Proportional Band Width	13:Pb	1.5	1.5 to 3.0	Room thermostat Proportional Band Width
Control mode ¹⁾	14:rC	1	0 or 2	0 – Room Temp control 1 – OTC control 2 – OTC control with room temperature compensation
OTC heat curve	15:OC	10	1 to 40	Set OTC heating curve
Reset Category 1 and 2 Parameters to Factory Defaults	19:FS	1	0/1	0: Settings in category 1, 2, 3 has been changed 1: Restore category 1 and 2 (not 3) to factory settings.

9.3 CM737-Category 2: ECO-functions

Parameter	Parameter N:o	Factory Default Setting	Optional Setting	
			Display	Description
Summer heating in OTC mode	1:SH	0	0 to 40	Minimum supply temp set point for heating. 0: function not active.
ECO function Summer reduction in OTC mode	2:SL	20	10 to 30	The outside temperature at which the heating will switch off. The economy function will be disabled if the setting for summer heating is not 0
ECO function Economy function in OTC mode	3:Pd	10	0 to 20	Difference between outside and calculated heating supply temperature. If the difference is less than 3:Pd value, the heating will be switch off. 0: function not active.

9.4 CM737-Category 3: Setting and displaying sensor values

Parameter	Parameter N:o	Factory Default Setting	Optional Setting	
			Display	Description
Maximum supply temperature set point ²⁾	1:CH	80	30 to 80	Maximum supply temp set point for heating.
DHW set point ²⁾	2:HS	80	-	Not applicable
Current Supply temperature	3:St	Actual temp	0-100	Display function
Return temperature	4:rt	--	--	Not applicable
DHW temperature	5:Ht	--	--	Not applicable
Outside temperature ³⁾	6:Ot	Actual temp	-40°C to 60°C	Display function
Water pressure ³⁾	7:Pr	--	--	Not applicable
DHW storage overnight	8:HO	1	0/1	Not applicable
DHW storage during HOLIDAY	9:HH	0	0/1	Not applicable
Low capacity control	10:LD	1	0/1	Not applicable

9.5 CM737-Category 4: Heating actuator settings



Changing category 4 must be carried out by an authorized service technician

Parameter	Parameter N:o	Factory Default Setting	Optional Setting	
			Display	Description
Proportional band	P 1	0	0-255	Proportional band for heating actuator, 1K.
Integral time	P 2	1	0-255	Integral time for heating actuator, 0.1 / minute.
Run time heating actuator	P 3	15	1-60	Time needed to open or close valve completely Value x 10= time needed in seconds.

9.6 CM737-Category 5: Fault History

(use right arrow button under display to access)

Parameter	Parameter N:o	Factory Default Setting	Optional Setting	
			Display	Description
Fault code log	FX	Fault code	F1-F10 plus fault code	Error code log has 10 posts. See 13.1 Fault Codes on the CM737.

The alarm log contains the 10 latest errors, beginning with the most recent error.

01 is generated at each restart.

0, 1, 0, 1, 0, 1, 0, 1, 0, 1 – means that the system has been correct restarted five times.





¹⁾ Only if the setting is allowed by the heating appliance. Standard settings and limits can be set by the heating appliance.

²⁾ Only available if supported by the heating appliance.

³⁾ Only available if the outside temperature sensor is mounted.

Notes: Always remember to press the green  button to confirm new Installer Set-Up setting. To exit the Installer Set-Up Mode press the **AUTO** or **MAN** button.

10 Troubleshooting the CM737

Symptom	Possible Cause	Remedy
A flashing  symbol appears on the display within one minute of the CM737 being powered on.	The CM737 receives power supply from the heating appliance, but no information.	The CM737 is not connected to the correct terminals of the heating appliance. Check if the wiring is connected to the Open Therm connection terminals of the heating appliance.
		The heating appliance is not configured correctly. Contact Cetetherm.
A  symbol appears permanently (no flashing) on the display.	Communication error due to an interrupt or short circuit in the link between the heating appliance and the CM737.	Check if the power supply cable of the heating appliance is connected.
		Check the wiring.
		Contact Cetetherm.
Display is blank	After installing the CM737 no power to the heating appliance is supplied and the rechargeable battery hasn't been charged (takes max 1hr until fully charged).	Check if the power supply cable of the heating appliance is connected otherwise contact Cetetherm.
	The power supply or the communication link between the CM737 and the heating appliance has been interrupted for more than 8 hrs.	Check if the power supply cable of the heating appliance is connected. After the power is restored the time may need to be adjusted – otherwise contact Cetetherm.
A flashing  symbol appears on the display after the CM737 being operating for a period	The heating appliance is showing an error	Press the  button, to see the error code. This fault code depends on the type of heating appliance See 10.1 Fault Codes on the CM737 .
A flashing  symbol appears on the display and the room temperature is replaced by “—“	Internal fault in the temperature measuring circuit.	Contact Cetetherm.

10.1 Fault Codes on the CM737

If a spanner is visible on the display, there is an on ongoing alarm. Press the Info-button to view the fault code.

Error source	Error code
No fault (power-up)	0
Supply water temperature sensor out of range	1
Outside air temperature sensor out of range	2
Case temperature out of range	3
Secondary pump or district heating supply	4
No OT communication	7

Fault code 0	This fault code can just be seen in the fault history, parameter settings category 5. Not via the Info- button.
Fault code 1	Supply sensor or cable
Cause	Measured supply water temperature is below 0 °C or above 100 °C.
Actions	The control panel turn the pump off and enter off mode (frost protection). Check the supply sensor and its cable.
Fault code 2	Outside sensor out of operating range. This fault code can only occur after the measured outside temperature has been in range: -40°C to 60°C.
Cause	Measured outside temperature is below -40 °C or above 60 °C
Actions	Enter room compensation until a valid temperature has been measured. Check the outside sensor and its cable.
Fault code 3	Connection box temperature out of operating range
Cause	Measured environment temperature is below -0 °C or above 60 °C.
Actions	The control panel turn the pump off and enter off mode (frost protection). Make sure that the substation is mounted in a well vented room.
Fault code 4	Cannot reach the set supply water temperature
Cause	Air in the pump, low temp/ not district heating supply.
Actions	Vent the pump, check the control valve and actuator.
Fault code 7	No communication between control panel and connection box
Cause	The connection box does not communicate with the control panel (by OT) for 60 seconds.
Actions	Fault is only cleared after a power break and OT communication is working again. Check the control panel cable.

11 Differential pressure control valve, DPC



Adjusting the DPC must be carried out by an authorized service technician.

11.1 Setting the DPC valve

Set the valve to the differential pressure 25kPa.
 Start with the valve at minimum position and then open with 3 numbers of turns.
 Use a 4mm hexagonal key.

NOTE: Always start from the minimum position of the valve, before making new settings.



Picture 21

11.2 Flow rate graph of the DPC

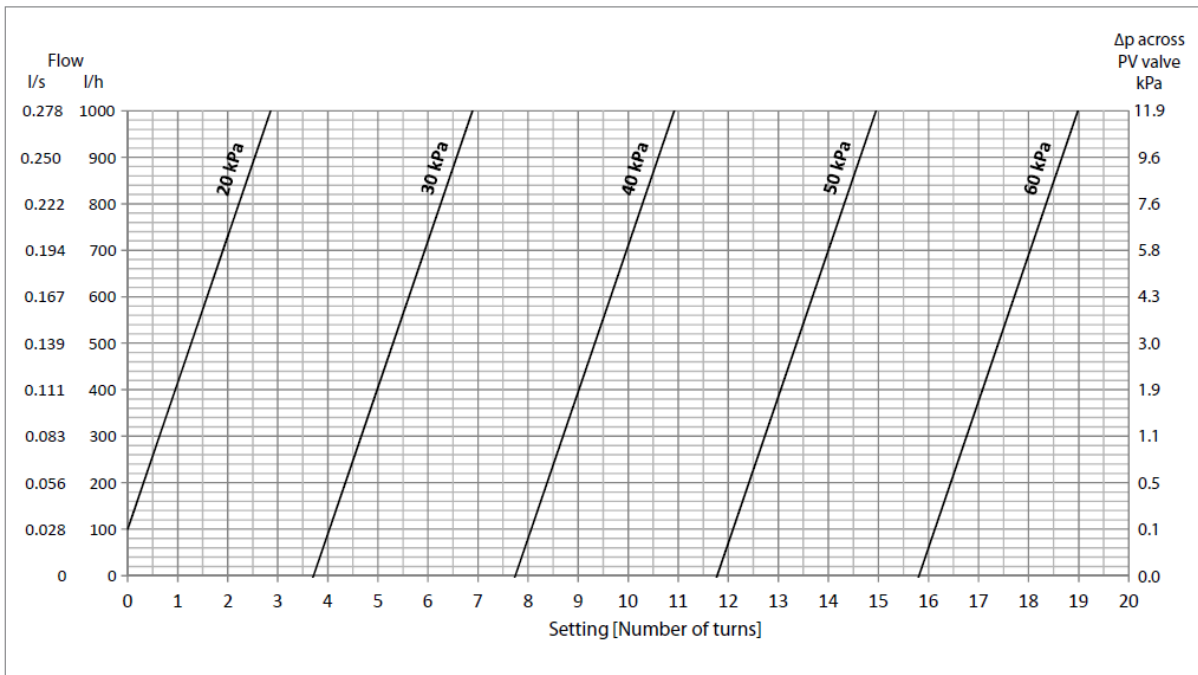

Picture 22

12 Pump settings and pump performance

The Micro STC is equipped with a Grundfos Alpha2L pump.

12.1 Grundfos Alpha2L settings

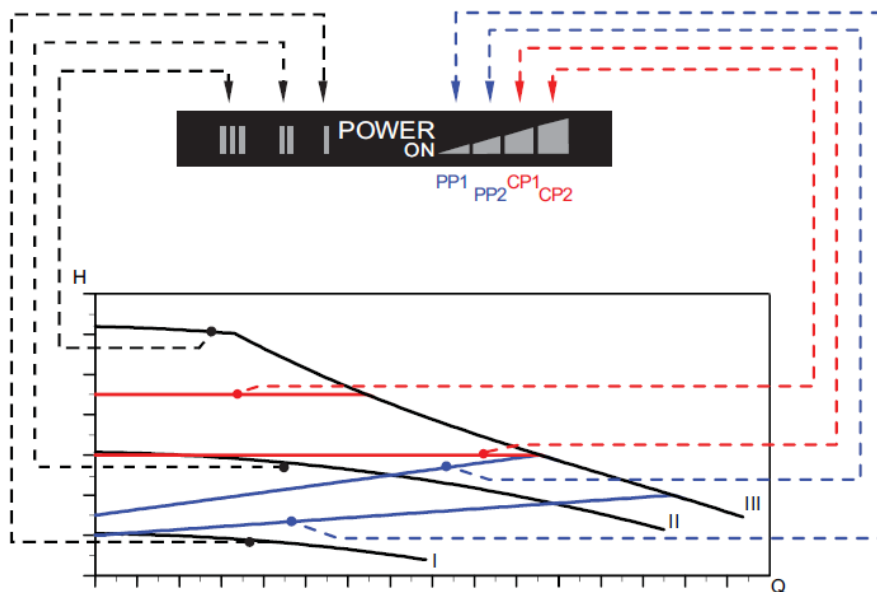

Picture 23

Settings	Pump curve	Function
PP1	Lowest proportional pressure curve	The duty point of the pump will move up or down on the lowest proportional-pressure curve, depending on the heating demand. The head (pressure) is reduced at falling heating demand and increased at rising heating demand.
PP2	Highest proportional pressure curve	The duty point of the pump will move up or down on the highest proportional-pressure curve, depending on the heating demand. The head (pressure) is reduced at falling heating demand and increased at rising heating demand.
CP1	Lowest constant pressure curve	The duty point of the pump will move out or in on the lowest constant-pressure curve, depending on the heating demand in the system. The head (pressure) is kept constant, irrespective of the heating demand.
CP2	Highest constant pressure curve	The duty point of the pump will move out or in on the highest constant-pressure curve, depending on the heating demand in the system. The head (pressure) is kept constant, irrespective of the heating demand.
III	Speed III	ALPHA2 L runs at a constant speed and consequently on a constant curve. In speed III, the pump is set to run on the max. curve under all operating conditions. Quick venting of the pump can be obtained by setting the pump to speed III for a short period.
II	Speed II	ALPHA2 L runs at a constant speed and consequently on a constant curve. In speed II, the pump is set to run on the medium curve under all operating conditions.
I	Speed I	ALPHA2 L runs at a constant speed and consequently on a constant curve. In speed I, the pump is set to run on the min. curve under all operating conditions.

12.2 Pump curve

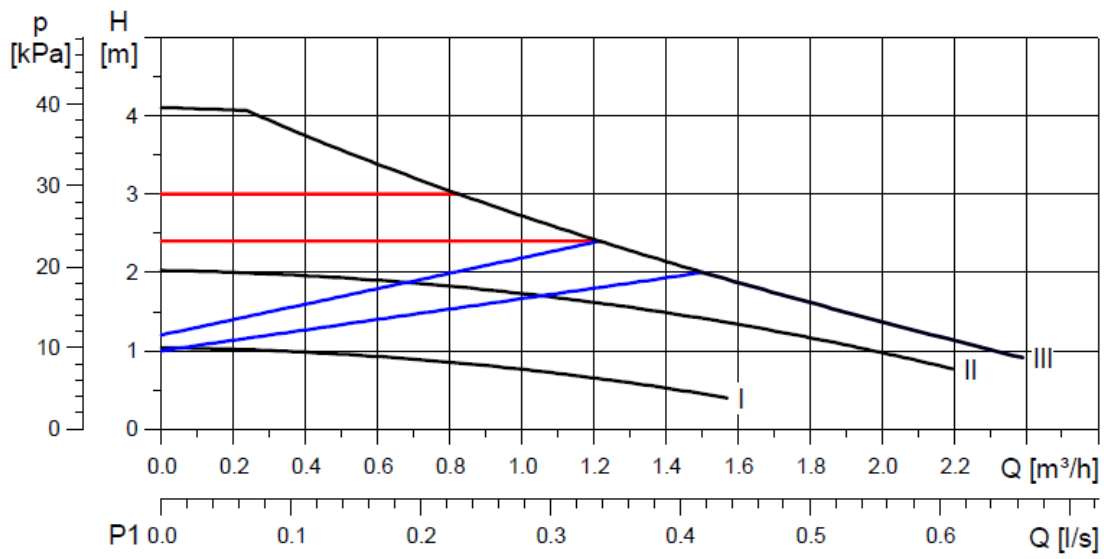

Picture 24

13 Electrical circuit diagram

13.1 Micro RTC

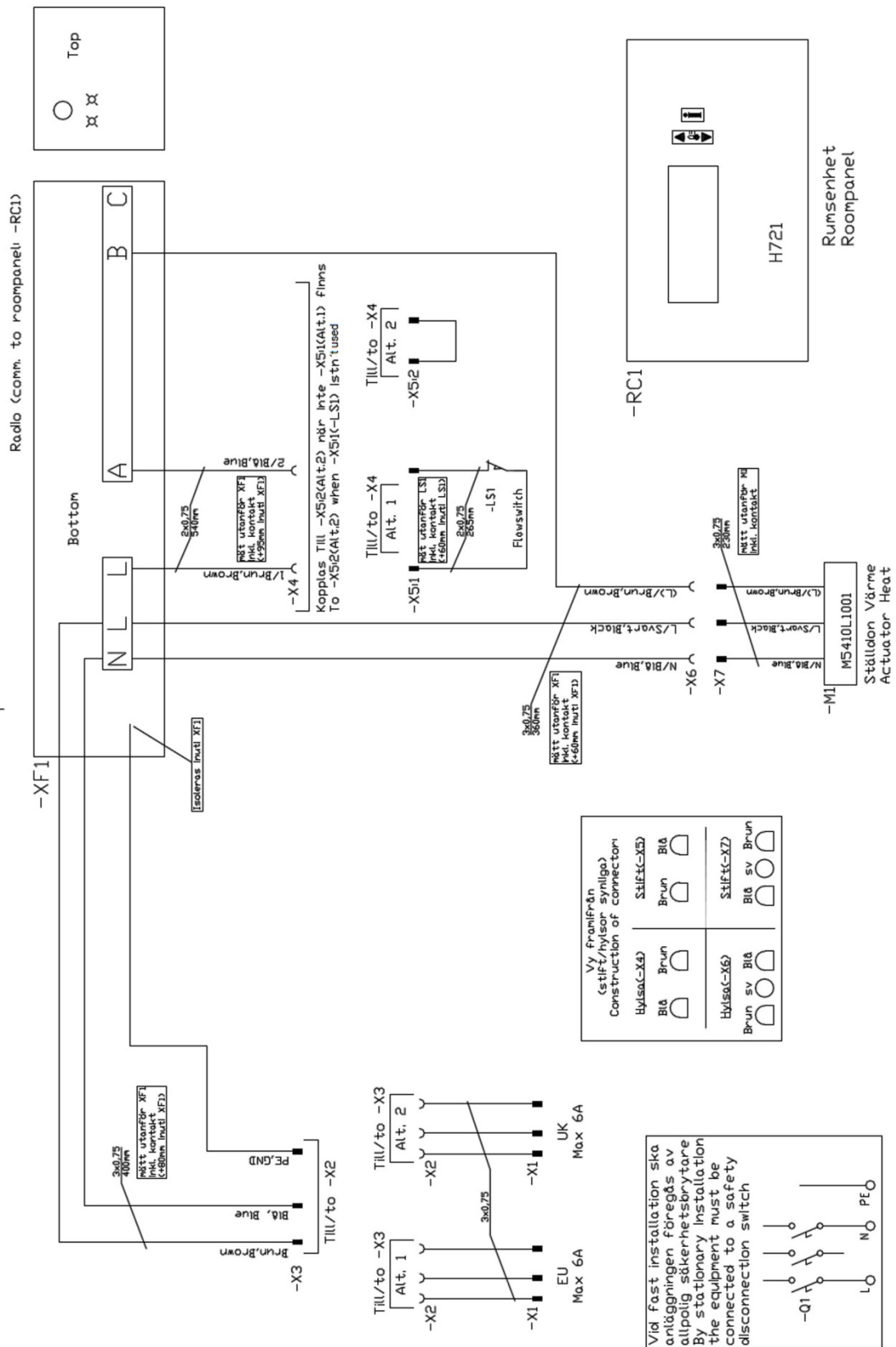

Picture 25

13.2 Micro STC and Micro STC2

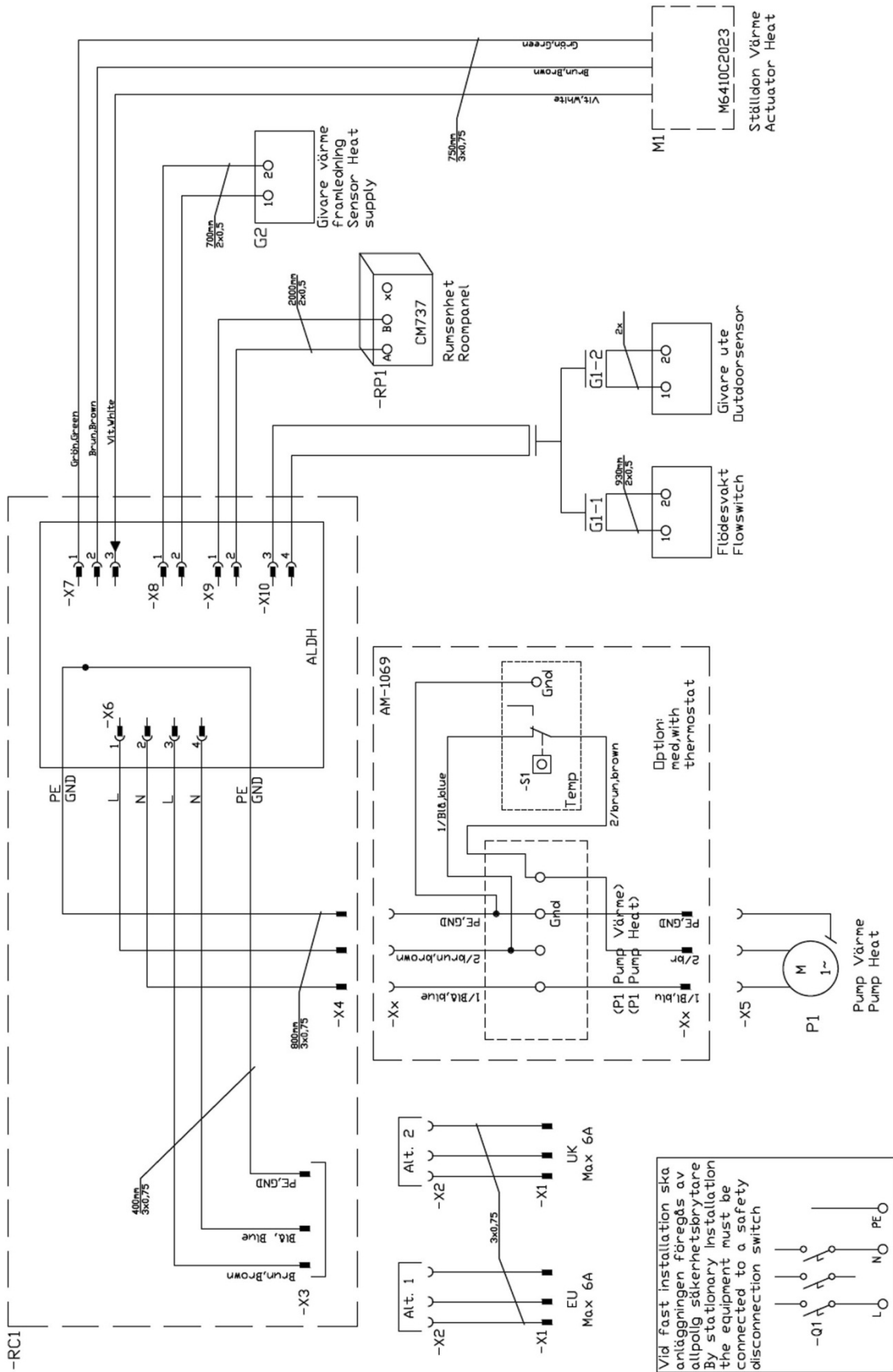

Picture 26

14 Service instructions

Always start with the general service instruction before the specific instructions for each model.



To avoid the risk of scalding, make sure that no-one draws any water while servicing the substation.



Grey marked service actions must be carried out by an authorized service technician.

NOTE! Make sure that the substation has been correctly installed.

14.1 General service instructions

14.1.1 Tap water temperature too low

Reason	Action
Primary heating supply too low	Check the primary inlet temperature The temperature can be checked by means of the energy meter (min 65° C) or contact the primary heating medium provider.
Handle on control valve incorrectly positioned	Adjust the handle on the control valve Control the hot water temperature by turning the handle on the control valve, counter clockwise to increase and clockwise to decrease tap water temperature. Adjust the hot water temperature by having a hot water tap open at normal flow rate. Measure the temperature at the draw-off point with a thermometer. It takes about 20 seconds to get a stable tap water temperature. The temperature should be minimum 50 °C. Cetetherm recommends that the primary inlet temperature is at least 10° higher than the tap water temperature. NOTE: Make sure that no cold water is mixed with the hot water while making this adjustment. Seal the hot water actuator after setting
Filter for heating media clogged	See 16.1 Cleaning the heating media filter
Hot water valve does not work	See 15.1 Check the function of the valve for hot water

14.1.2 Tap water temperature too high

Reason	Action
Handle on control valve incorrectly positioned	Adjust the handle on the control valve Control the hot water temperature by turning the handle on the control valve, counter clockwise to increase and clockwise to decrease tap water temperature. Adjust the hot water temperature by having a hot water tap open at normal flow rate. Measure the temperature at the draw-off point with a thermometer. It takes about 20 seconds to get a stable tap water temperature. The temperature should be minimum 50 °C. Cetetherm recommends that the primary inlet temperature is at least 10° higher than the tap water temperature. NOTE: Make sure that no cold water is mixed with the hot water while making this adjustment. Seal the hot water actuator after setting

Cetetherm Micro

Installation, service and operating instruction

Hot water valve and/or actuator does not work	Check the valve according to 15.1 Check the function of the valve for hot water If the water temperature is too high when the handle is in position 0, the actuator or the exchanger is damaged and requires replacing.
---	---

14.1.3 Hot water temperature unstable or too low

Reason	Action
Alternating pressure on primary side	Check available differential pressure and temperature at the primary heating medium provider
Filter for heating media clogged	See 16.1 Cleaning the heating media filter.

14.1.4 Heating system temperature too high or too low

Reason	Action
Filter for heating media clogged	See 16.1 Cleaning the heating media filter.
Differential pressure control valve incorrectly adjusted (option)	See 11 Differential pressure control valve, DPC.

14.1.5 No heating

Reason	Action
Closed radiator or floor heating valves	Check that all radiator valves and floor heating valves are fully open
Filter for heating media clogged	See 16.1 Cleaning the heating media filter.
Differential pressure control valve incorrectly adjusted(option)	See 11 Differential pressure control valve, DPC

14.1.6 Heating temperature unstable

Reason	Action
Alternating pressure on primary side	Check available differential pressure and temperature at the primary heating medium provider
Filter for heating media clogged	See 16.1 Cleaning the heating media filter.
Differential pressure control valve incorrectly adjusted (option)	See 11 Differential pressure control valve, DPC

14.2 STC service instructions



Hand manoeuvre of the heating actuator

The room thermostat must be without current when manoeuvring the actuator by hand.

NOTE: if manually adjusting the actuator, the operator control panel must be restarted before use.

14.2.1 Heating system temperature too high or too low

Reason	Action
The heating control equipment may need to be adjusted	<p>Check and adjust the heating curve If needed the set heating curve can be fine-tuned. Increase/ decrease the room temperature by parallel adjust the heating curve.</p> <p>Control panel Round <i>See 6.3 Changing control mode, OTC heating curve and max supply temperature.</i></p> <p>Control panel CM737 <i>See 9.2 CM737–Category 1: Control panel settings</i> and change the selected heating curve with parameter 15 category 1.</p> <p>Also see section <i>8.5 OTC heating curve</i> and <i>8.6 Parallel adjustment of heating curve</i>.</p>
Heating valve and/or actuator does not work	<i>See 15.2 Check the function of the heating actuator and valve</i>
Heating supply temperature sensor and outdoor temperature sensor (option) does not work	<p>Check that the heating supply temperature sensor and outdoor temperature sensor are correctly sited and working.</p> <p>Control panel Round: Supply temperature can only be viewed in control mode 4 and 5.</p> <p>Control panel CM737: To confirm that sensors are connected and operating, press the info button on the operator control panel, check that the specified temperatures are reasonable.</p>

14.2.2 No heating

Reason	Action
Circulation pump not running	Check that the electrical power is on
	Check the circulation pump If the pump fails to start after stopping, try to start it at the highest setting.
	<p>Check the heating parameters in room thermostat If measured outdoor temperature is higher than target temperature, the pump should not be operating.</p> <p>Control panel CM737 Check the heating parameters in operator control panel Summer reduction, parameter 2, category 2: If measured outdoor temperature is higher than target temperature, the pump should not be operating.</p> <p>Economy function, parameter 3, category 2: If the calculated water supply temperature is not greater than the outside temperature by this amount the heating will switch off. If parameter 3 is 0, the pump operation will not be affected by this parameter</p>

Cetetherm Micro

Installation, service and operating instruction

Heating supply temperature sensor and outdoor temperature sensor (option) does not work	<p>Check that the heating supply temperature sensor and outdoor temperature sensor are correctly sited and working.</p> <p>Control panel Round: Supply temperature can only be viewed in control mode 4 and 5.</p> <p>Control panel CM737: To confirm that sensors are connected and operating, press the info button on the operator control panel, check that the specified temperatures are reasonable.</p>
Loss of function in the heating control unit.	See 15.3 Run the pump manually

14.2.3 Disturbing noise from the circulation pump/ Noise in the radiator system

Reason	Action
Pump capacity set too high	<p>Reduce the pump capacity The pump has been set at a too high capacity level. Reduce the level by choosing a lower output setting on the pump. The lowest setting is the most economical.</p>
Air in the pump	<p>Vent the pump The pump is self-venting. Air in the pump may cause noise. This noise ceases after a few minutes run time. Quick venting of the pump can be obtained by setting the pump to speed III for a short period, depending on system size and design. When the pump has been vented, i.e. when the noise has ceased, set the pump according to the recommendations.</p>
Pump motor or pump component damaged	See 16.6 Change pump components or the complete pump
Differential pressure control valve set too high	See 11 Differential pressure control valve, DPC

14.2.4 Heating temperature unstable

Reason	Action
Heating supply temperature sensor and outdoor temperature sensor (option) does not work	<p>Check that the heating supply temperature sensor and outdoor temperature sensor are correctly sited and working.</p> <p>Control panel Round: Supply temperature can only be viewed in control mode 4 and 5.</p> <p>Control panel CM737: To confirm that sensors are connected and operating, press the info button on the operator control panel, check that the specified temperatures are reasonable.</p>

14.3 HTC service instructions

14.3.1 Tap water temperature too low/ hot water temperature unstable or too low

Reason	Action
Differential pressure control valve incorrectly adjusted (option)	See 11 Differential pressure control valve, DPC

14.3.2 Heating system temperature too high or too low

Reason	Action
Heating valve and/or actuator does not work.	See 15.2 Check the function of the heating actuator and valve

15 Service actions for the installer

15.1 Check the function of the valve for hot water



Service actions must be carried out by an authorized service technician.



Close the shutoff valves for the **Heating network supply** and **Heating network return** together with the **cold** and **hot water**.



After finishing repair; open the shutoff valves. Start with **Heating network supply** and then the **return** line, to avoid pollutions in the system. Open the valves slowly to avoid pressure surges.

1. Disconnect the power feed to the substation.
2. Close the shut-off valves.
3. Unscrew the tap water actuator from the control valve.
If the valve is working it should be fully open when the actuator is removed.
Check that hot water passes through the valve. Feel gently on a pipe after the valve.
4. Carefully press the valve's spindle with a tool and check the valve's travel and spring back.
NOTE: The valve may be very hot!
5. Turn the handle on the actuator; a small stem should move in and out. If the stem does not move the actuator is damaged and requires replacing.
6. Connect the power feed to the substation.
7. Open the shutoff valves.

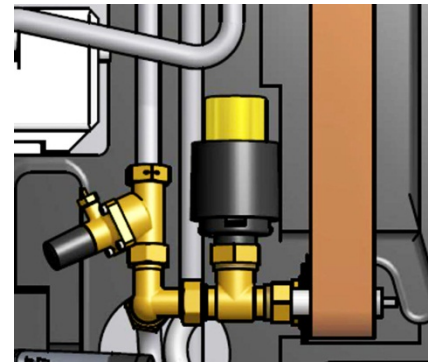

Picture 27

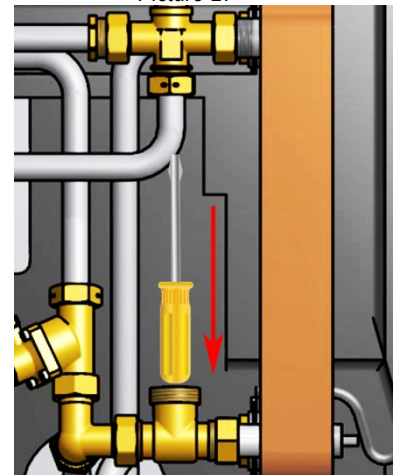

Picture 28

15.2 Check the function of the heating actuator and valve



Service actions must be carried out by an authorized service technician.



The room thermostat must be without current when manoeuvring the actuator by hand.

1. Check the actuator by pulling out the electrical cable and refit it again; this will start an automatic self-test off the actuator and pump.
See 4.12 Starting up sequence with component check.
2. Check the flow using the energy meter while test-running the valve.
If no energy meter is available, disconnect the heating actuator from the valve. Close the actuator by turning the knob clockwise, this will make it easier to reattach.
3. Carefully depress the valve's spindle with a tool and check the valve's travel and spring back.
Note! The valve may be very hot

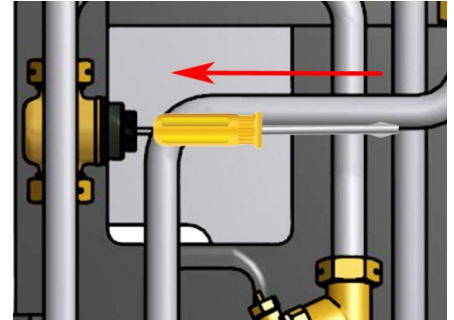

Picture 29

15.3 Run the pump manually



Service actions must be carried out by an authorized service technician.

If it becomes necessary to run the pump and actuator manually, this can be done by disconnecting the power to the room thermostat.

Disconnect the electrical plug for the pump. Connect the replacement cable (option) to the power supply and to the circulation pump. Next, open the heating valve manually using the knob on the actuator. Open the control valve sufficiently to satisfy the heating needs.

16 Maintenance and repairs

When carrying out repairs, please contact your local service partner.



Before starting out repairs always close the correct shutoff valves.



When dismantling a component there will be water coming out, hot and under pressure.

16.1 Cleaning the heating media filter



Service actions must be carried out by an authorized service technician.



The temperature and the pressure of the district heating water are very high. Only qualified technicians can work with the district heating substation. Incorrect operation may cause serious personal injury and result in damage to the building.



Before starting out repairs close the **heating network supply** and **heating network return** shutoff valves.



After finishing repair; open the shutoff valves. Start with **heating network supply** and then the **return** line, to avoid pollutions in the system. Open the valves slowly to avoid pressure surges.

1. Disconnect the power feed to the substation.
2. Close the shut-off valves.
3. Use a wrench and release the filter cover and remove the cartridge.
4. Clean the filter with water and refit the cartridge. Screw the filter cover with a momentum of 10-20 Nm.
5. Open the shutoff valves and connect the power feed to the substation.

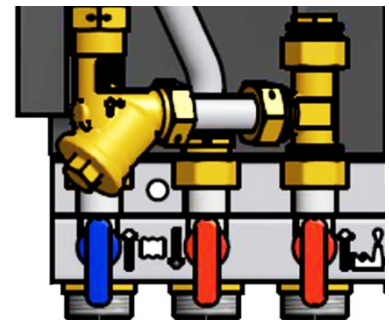

Picture 30

16.2 Change the hot water actuator and heat exchanger



The temperature and the pressure of the district heating water are very high. Only qualified technicians can work with the district heating substation. Incorrect operation may cause serious personal injury and result in damage to the building.



Before starting out repairs close the **heating network supply** and **heating network return** shutoff valves.



After finishing repair; open the shutoff valves. Start with **heating network supply** and then the **return** line, to avoid pollutions in the system. Open the valves slowly to avoid pressure surges.

1. Disconnect the power feed to the substation.
2. Close the shut-off valves.
3. Unscrew the actuator from the control valve.
4. Release the four nuts on the heat exchanger.
5. Refit a new heat exchanger and actuator. Use new gaskets and tighten with 45Nm.
6. Mount the actuator on the valve.
7. Open the shutoff valves and connect the power feed to the substation.

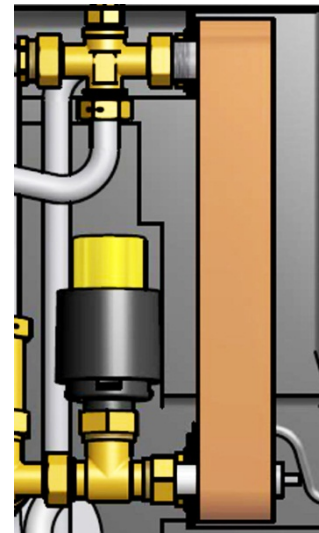

Picture 31

16.3 Change the hot water valve



The temperature and the pressure of the district heating water are very high. Only qualified technicians can work with the district heating substation. Incorrect operation may cause serious personal injury and result in damage to the building.



Before starting out repairs close the **heating network supply** and **heating network return** shutoff valves.



After finishing repair; open the shutoff valves. Start with **heating network supply** and then the **return** line, to avoid pollutions in the system. Open the valves slowly to avoid pressure surges.

1. Disconnect the power feed to the substation.
2. Close the shut-off valves.
3. Unscrew the tap water actuator from the control valve.
4. Use a spanner to remove the control valve. **Note** the arrow direction on the valve.
5. Mount a new valve; and take especially care to the arrow direction. Use new gaskets and tighten with 45Nm.
6. Fasten the tap water actuator on the valve.
7. Open the shutoff valves and connect the power feed to the substation.

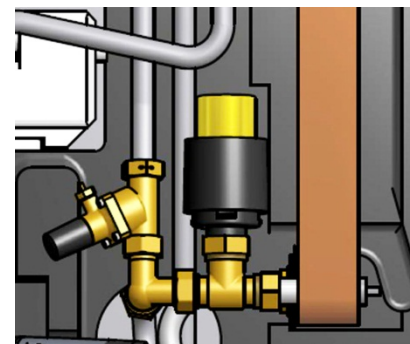

Picture 32

16.4 Change the heating actuator



Maintenance and repairs must be carried out by an authorized service technician.

1. Disconnect the electrical power supply.
2. Disconnect the cable from heating actuator in the connection box.
3. Unscrew the heating actuator from the valve, the valve closes.
4. Cut off all straps that holds the actuator cable.
5. Make sure that new actuator is closed by turning the knob clockwise to the closing position. Fasten the actuator, use only hand power.
6. Replace cable and straps.
7. Connect the power feed to the substation.
8. Check the function of the actuator during start up.

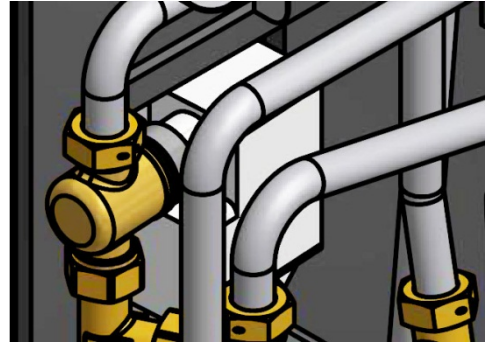

Picture 33

16.5 Change the heating valve



The temperature and the pressure of the district heating water are very high. Only qualified technicians can work with the district heating substation. Incorrect operation may cause serious personal injury and result in damage to the building.



Before starting out repairs close the **heating network supply** and **heating network return** shutoff valves.



After finishing repair; open the shutoff valves. Start with **heating network supply** and then the **return** line, to avoid pollutions in the system. Open the valves slowly to avoid pressure surges.

1. Disconnect the power feed to the substation.
2. Close the shut-off valves.
3. Unscrew the heating actuator from the control valve.
4. Use a wrench to remove the control valve.
Note the arrow direction on the valve.
5. Mount a new valve; and take especially care to the arrow direction.
Use new gaskets and tighten with 45Nm.
6. Close the actuator by turning the knob clockwise to the closing position. Fasten the actuator, use only hand power.
7. Open the shutoff valves and connect the power feed to the substation.



Picture 34

16.6 Change pump components or the complete pump



Maintenance and repairs must be carried out by an authorized service technician.



Before starting out repairs, close the shutoff valves **heating network supply**, **heating network return**, **heating supply** and **heating return**.

Change the complete pump or just change the pump motor.

1. Disconnect the power feed to the substation, disconnect the power cable to the pump.
2. Close the shut-off valves.
3. Choose alternative a or b.
 - a) When changing the complete pump, release the brass nuts with a spanner and replace the pump. Connect the pump cable.
 - b) Only changing the motor, release it by unscrewing four sockets head cap screws and replace the motor. Connect the pump cable.
4. Open the shut-off valves and connect the power feed to the substation.



Picture 35

16.7 Change the heating circuit supply temperature sensor

1. Disconnect the power feed to the substation.
2. Disconnect the quick-connect terminals and replace the sensor with a new one.
3. Connect the power feed to the substation.
4. Check the sensors value on the control panel after 5 min.



Picture 36

16.8 Change the outdoor temperature sensor

1. Disconnect the power feed to the substation.
2. Unscrew the lid of the outdoor temperature sensor by turning it anti-clockwise.
3. Unscrew the cables and loosen the cable fitting.
4. Install a new outdoor temperature sensor.
5. Connect the power feed to the substation.
6. Check the sensors value on the control panel after 5 min.



Picture 37

16.9 Change the differential pressure control valve



The temperature and the pressure of the district heating water are very high. Only qualified technicians can work with the district heating substation. Incorrect operation may cause serious personal injury and result in damage to the building.



Before starting out repairs close the **heating network supply** and **heating network return** shutoff valves.



After finishing repair; open the shutoff valves. Start with **heating network supply** and then the **return** line, to avoid pollutions in the system. Open the valves slowly to avoid pressure surges.

1. Disconnect the power feed to the substation.
2. Close the shut-off valves.
3. Use a spanner to remove the differential pressure control valve. **Note** the position of the P/T plugs on the valve.
4. Mount a new valve; and take especially care to the P/T plugs position.
5. Open the shutoff valves and connect the power feed to the substation.

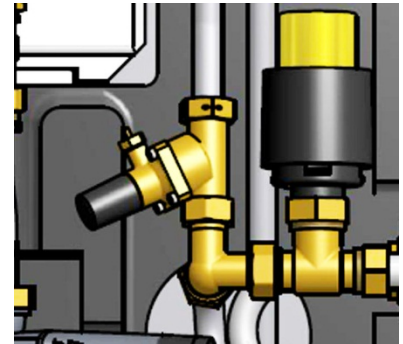

Picture 38

16.10 Change the flow switch



Maintenance and repairs must be carried out by an authorized service technician.



Before starting out repairs always close the primary supply and return shutoff valves
After finishing repair; open the shutoff valves. Start with primary supply and then the return lines, to avoid pollutions in the system. Open the valves slowly to avoid pressure surges.

1. Disconnect the substation electrical power supply cable. Disconnect the electrical plug to the flow switch.
2. Loosen the nut that holds the flow switch.
3. Carefully mount the new flow switch.
4. **Note:** Hold the flow switch in position when tightening the nut by hand. The flow switch breaks if it is turned around with the nut.
5. Connect the power plug and the substation electrical power supply.

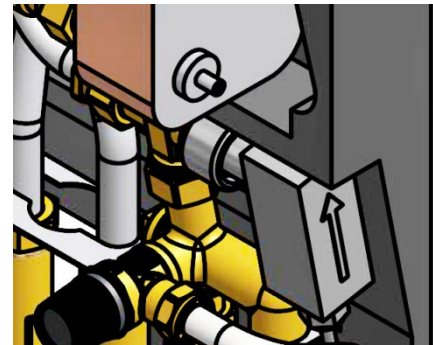

Picture 39

17 Operating data and performance

17.1 Operating data

Operating data			
	Heating medium	Heating circuit	Hot water circuit
Design pressure, MPa	1,0 (1,6) ¹⁾	1,0	1,0
Design temperature, °C	100 (120) ¹⁾	100	100
Opening pressure, safety valve, MPa			0,9
Volume, l	0,34	---	0,36 (0,38) ²⁾

¹⁾ AquaMicro
²⁾ Micro HTC

17.1.1 AquaMicro

Performance at available differential pressure 50-600 kPa				
Designed temperature programme (°C)	Capacity (kW)	Primary flow (l/s)	Actual return temp. (°C)	Secondary flow (l/s)
Hot water circuit				
80-25/10-55	79	0,34	25	0,42
70-25/10-58	36	0,19	25	0,18
65-25/10-50	55	0,33	25	0,33

17.1.2 Micro DPC, Micro RTC, Micro HTC, Micro STC, Micro STC2

Performance at available differential pressure 50-400 kPa				
Designed temperature programme (°C)	Capacity (kW)	Primary flow (l/s)	Actual return temp. (°C)	Secondary flow (l/s)
Hot water circuit				
Micro DPC, Micro RTC, (Micro HTC), Micro STC, Micro STC2				
80-25/10-55	79 (66)	0,34 (0,29)	25	0,42 (0,35)
70-25/10-58	36 (29)	0,19 (0,15)	25	0,18 (0,14)
65-25/10-50	55 (46)	0,33 (0,28)	25	0,33 (0,28)
Heating Circuit 1				
Micro DPC, Micro RTC (Micro HTC)				
80-50 (80-60)	10	0,08 (0,12)	50 (60)	0,08 (0,12)
Heating circuit 1				
Micro STC, Micro STC2				
80-50/50-70	10	0,08	50	0,12
80-60/60-70	7	0,08	60	0,16
80-45/45-60	12	0,08	45	0,19
80-30/30-35	7	0,03	30	0,33
Heating circuit 2				
Micro STC2				
80-50	10	0,08	50	0,08

17.2 Technical Data

Main measures	See Measure sketch
• With cover	430x160x775 (mm, WxDxH)
• Without cover	400x120x630 (mm, WxDxH)
Weight	12-15kg, cover 2kg
Electrical connection	
• Micro STC & Micro STC2	230 V, 1-phase, 50 W
• Micro RTC	230 V, 1-phase, 25 W
• Micro HTC	230 V, single phase, 2 W
Transportation	Total weight 19-22 kg, 0.08 m ³
Sound level	<70dB (A) 1.6 m from floor, 1 m from unit

17.3 Measure sketch

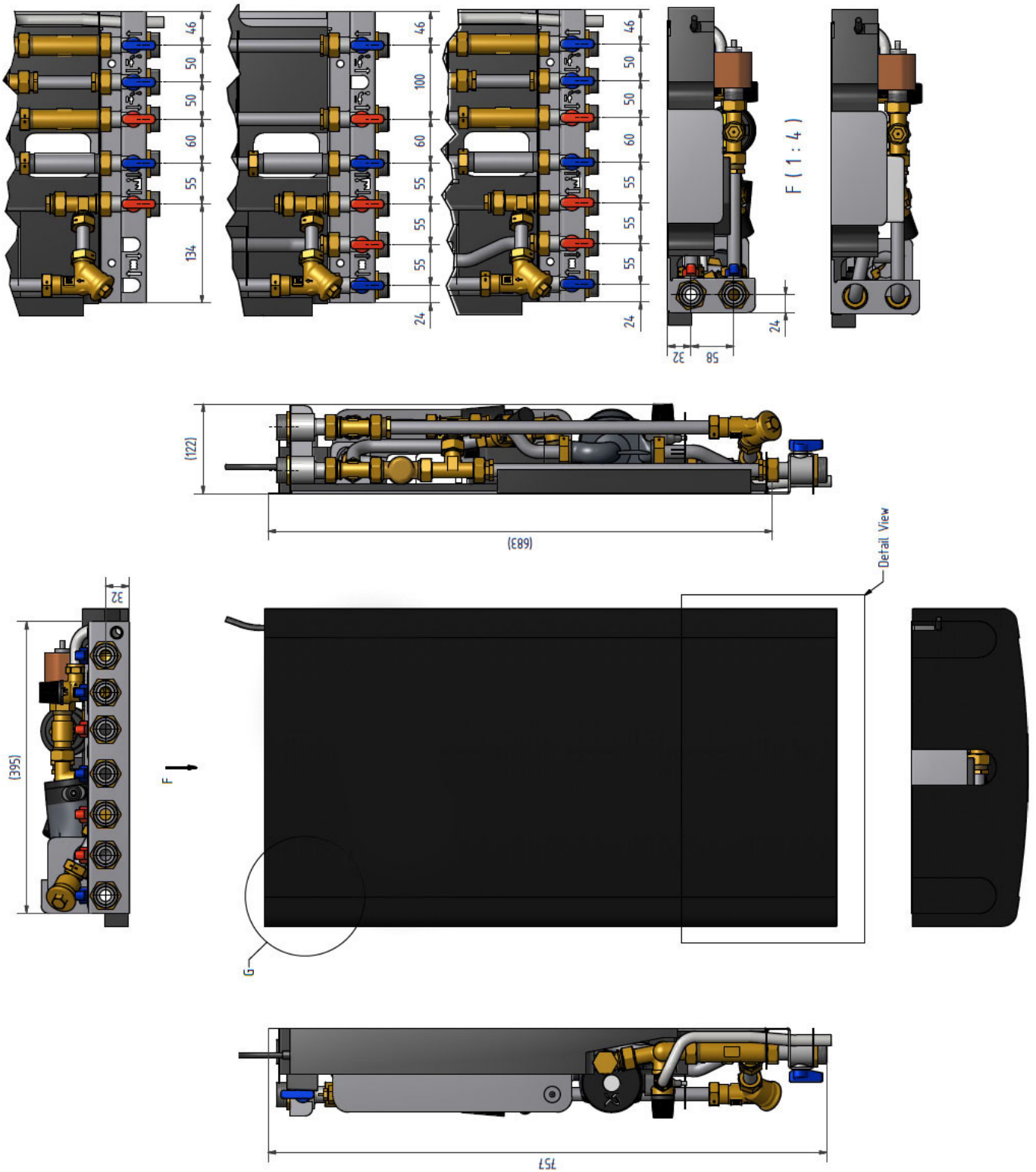

Picture 40

18 Options

The mounting instructions are described for a new installation. If the kits are supposed to be installed on an already installed subsystem, release the water pressure and disconnect the electrical power supply before starting. The options must be installed by an authorized installation contractor.

18.1 Safety thermostat

Heating systems sensitive to high temperatures for example under-floor heating must be equipped with a safety thermostat. If the heating system is not equipped with the thermostat, the under-floor heating system and floors in general might get damaged

18.2 Installing the safety thermostat

1. First disconnect the substation electrical power supply cable. Disconnect the electrical plug on the circulation pump.
2. Attach the safety thermostat electrical box.
Connect the new power supply cable from the electrical box to the circulation pump.
3. Reconnect the existing power supply cable to the connection on the electrical box.
4. Attach the thermostat to the pipe for heating supply.
5. Set the correct maximum temperature value for the thermostat.
6. Attach all electrical wires with the necessary number of straps. It is important not to attach electrical wires on primary heating pipes and sharp edges.
7. Change parameters and recommended settings before starting up the system with a safety thermostat

18.2.1 Parameters and recommended settings for under floor heating

The following changes must be done before starting up with a safety thermostat.

Control panel Round:

See [6.3 Changing control mode, OTC heating curve and max supply temperature](#) and

1. Change the supply temperature to maximum 45 °C.
2. Change room thermostat heat curve to 5.

Control panel CM737:

Parameter	Parameter N.o	Set to	Optional Setting	
			Display	Description
Category 1 parameters: Control panel settings				
OTC heat curve	15:OC	5	1 to 40	Set OTC heating curve
Category 2 parameters: ECO-functions				
ECO function Economy function in OTC mode	3:Pd	0	0 to 20	Difference between outside and calculated heating supply temperature. If the difference is less than 3:Pd value, the heating will be switch off. 0: function not active.
Category 3 parameters: Setting and displaying sensor values				
Maximum supply temperature set point	1:CH	45	30 to 80	Maximum supply temp set point for heating.

18.3 First fix-jig

To save time and efficiency the installation, Cetetherm offers a first-fix- jig including shut-off valves. The first fix-jig is available in three different models, with five, six or seven shut-off valves.

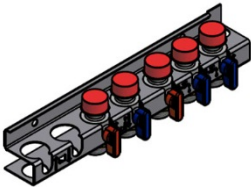

Picture 41

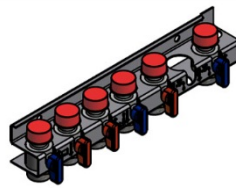

Picture 42

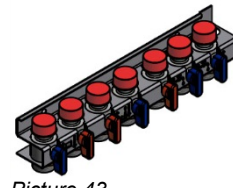

Picture 43

- Mount the first fix-jig to the connection points. Tighten with 45 Nm.
- Mount and connect the substation to the first fix-jig. Tighten with 45 Nm.

Cetetherm AB
Fridhemsvägen 15
372 38 Ronneby – Sweden
www.cetetherm.com

Cetetherm
NIBE GROUP MEMBER