

# Cetetherm

## Installation, service, and operating instruction Cetetherm Mini Select

District heating substation for multi-family buildings (4-30 apartments) and smaller premises

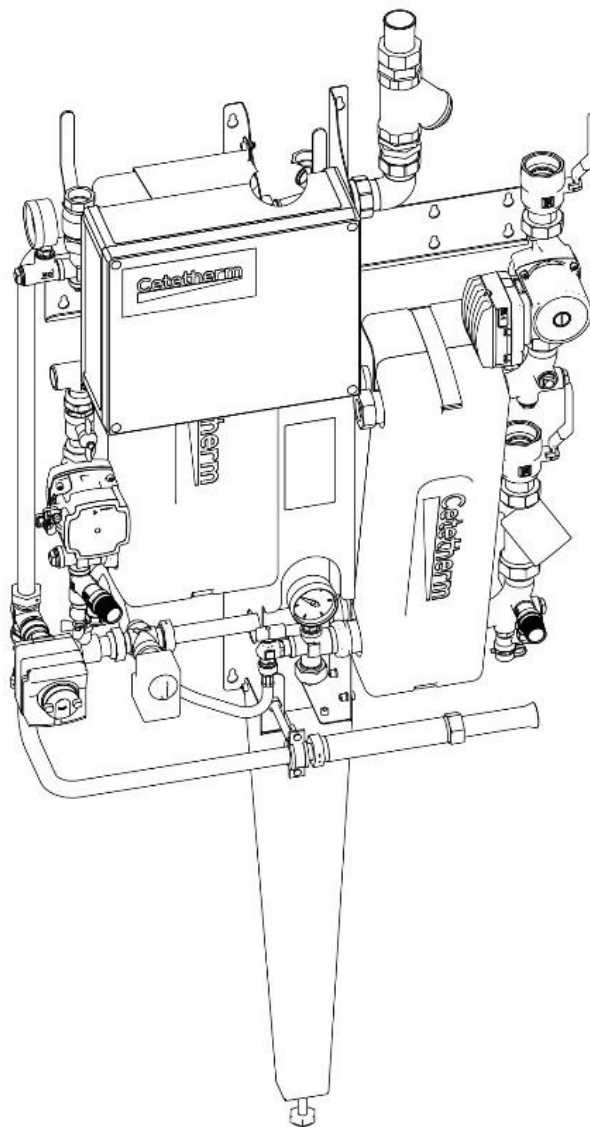

**For additional on-line information and latest version of this manual:**

<https://www.cetetherm.com/miniselect>

QR-kod:



This manual is published by Cetetherm.

Cetetherm can without further notice make changes and improvements to the content in this manual if it is necessary due to printing mistakes, wrong information or changes in the hardware or software.

All these types of changes will be included in future release of the manual.

# Innehåll

<b>1</b>	<b>General .....</b>	<b>2</b>
1.1	Comfort .....	2
1.2	Installation .....	2
1.3	Long-term security .....	2
1.4	CE-marking.....	2
1.5	Information about the document.....	2
1.6	Technical data .....	2
1.7	General warnings .....	3
<b>2</b>	<b>Operating instructions.....</b>	<b>4</b>
2.1	Operation .....	4
2.2	Safety equipment/inspection .....	4
<b>3</b>	<b>Product overview .....</b>	<b>5</b>
3.1	Measure sketch .....	6
3.2	Wall rail – measurement.....	7
<b>4</b>	<b>Mounting and installation.....</b>	<b>8</b>
4.1	Unpacking.....	8
4.2	Preparation .....	8
4.3	Mounting .....	8
4.4	Adjustments and settings .....	9
4.5	Dismantlement.....	10
4.6	Commissioning .....	10
<b>5</b>	<b>Schematic diagram, main components .....</b>	<b>11</b>
<b>6</b>	<b>Electrical connections .....</b>	<b>12</b>
6.1	General .....	12
6.2	Installation of the outdoor temperature sensor.....	12
<b>7</b>	<b>Service instruction.....</b>	<b>13</b>
7.1	Service instruction, tap water .....	13
7.1.1	Tap water temperature low .....	13
7.1.2	Tap water temperature is too hot .....	13
7.1.3	Hot water temperature unstable .....	13
7.1.4	Noise in the DHWC system.....	14
7.2	Service instructions, heating circuit .....	14
7.2.1	Heating system temperature too high or too low .....	14
7.2.2	No heating .....	14
7.2.3	Noise in the radiator system.....	14
7.2.4	Heating system often need topping up.....	15
<b>8</b>	<b>Service actions for the installer .....</b>	<b>16</b>
8.1	Check the function of the valve and actuator for hot water .....	16
8.2	Check the heating actuator and valve function .....	16
8.3	Check the circulation pump .....	17
8.4	Check the volume take-up and pressure equalizing of the expansion vessel .....	17
<b>9</b>	<b>Maintenance and repairs .....</b>	<b>18</b>
9.1	Cleaning the district heating filter .....	18
9.2	Cleaning the heating circuit filter .....	18
9.3	Maintenance of components in the heating circuit .....	19
9.4	Maintenance of components in the hot water circuit .....	19

# 1 General

Cetetherm Mini Select is a complete, ready-to-install heating network substation for heating and hot water. It is designed for buildings with a primary connection to a heating network. Cetetherm has years of experience in heating network technology and has developed Mini Select with well-planned pipe work and with all components easily accessible for inspection and possible future servicing.

## 1.1 Comfort

Mini Select has fully-automatic temperature control for heating and hot water. The hot water is controlled and maintained at the desired temperature.

## 1.2 Installation

Before installation this manual must be read.

Well planned pipe work make installation very simple.  
Mini Select shall be mounted on a stable wall with the floor support.

## 1.3 Long-term security

The heat exchanger plates, and the pipes are made of acid-resistant stainless steel for long life.  
All components are closely matched and carefully tested to function in accordance with 3rd party certified quality assurance system ISO 9001.

For future servicing requirements, all components are easily accessible and individually replaceable.

## 1.4 CE-marking

Mini Select is CE-marked to certify that it fulfills international safety regulations.  
To maintain the validity of the CE marking, only identical replacement parts must be used.









## 1.5 Information about the document

All pictures in this document are general images.  
Mini Select is available in different models, with different components and options.

## 1.6 Technicla data

See the type plate.

## 1.7 General warnings

	The installation work must be carried out by an authorized installation contractor. Before the system is taken into operation, it must be filled up and checked for leaks.
	The temperature and the pressure of the primary heating water are very high. Only qualified technicians can work with the substation. Incorrect operation may cause serious personal injury and result in damage to the building.
	If the hot water temperature is set too high, people may be scalded. If the hot water temperature is set too low, unwanted bacteriological growth may occur in the hot water system. This can result in serious personal injury.
	Parts of the substation may get very hot and should not be touched.
	Before the substation is connected to the electrical supply, the hot water circuit must be connected and make sure that the heating system is topped up with water. Starting up the system without water will damage the circulation pump.
	When starting up the substation: To avoid the risk of scalding, make sure that no-one draws any hot water until the hot water temperature has been adjusted.
	Start heating circulation by first opening the valves in the district heating supply and then return lines, to avoid pollutions in the system. Open the valves slowly to avoid pressure surges. Do the same with the heating circuit, but first open heating return and then supply.
	The substation should be placed in a locked area where non-authorized persons do not have access.

## 2 Operating instructions

### 2.1 Operation

The temperature and pressure of the incoming heating network water are very high. For this reason, only the heat from this water is used. The heating network water does not enter the heating and hot water systems of the building.

The heat from the heating network water is transferred to the heating and hot water systems of the building in the heat exchangers. The heat is transferred through thin plates of acid-resistant stainless steel which keep the heating network water completely separated from the systems in the building.

Mini Select is equipped with two circulation pumps, one for the hot water circulation, DHWC-pump, and one for the heating circuit.

Mini Select has automatic temperature control for heating and hot water. The hot water temperature is controlled by a temperature control system which is set to about 55 °C.

After adjustment, the Mini Select operates completely automatic. However, in hard water areas it is advisable to be attentive and to remedy any faults in good time if the temperature of the hot water is too high; otherwise, the risk of lime deposits in the heat exchanger may increase.

### 2.2 Safety equipment/inspection

- Daily inspection to check for leaks from pipes or components.
- Weekly inspection to make sure that the operation of the heating and hot water control systems is stable, and that the temperature does not fluctuate. Fluctuations in temperature causes unnecessary wear of valves, actuators, and heat exchangers
- Every three months check the safety valves and the pressure in the heating system.

To check the operation of the safety valve, turn its knob until water escapes from the waste pipe of the valve, and then close the knob quickly. Occasionally a safety valve may open automatically to release excess pressure. After a safety valve has been opened it is important that it closes properly and does not drip.

Hot water temperature in apartments or one family houses can be set to about 55°C. If the temperature is set too high, there is a risk of scalding. Setting the hot water temperature too low may result in unwanted bacteriological growth in the hot water system.

For setting and (if necessary) fine adjustment of the heating and hot water temperatures, see controller manual.

The heating system is topped up via the heating filler valves. Be sure to close the valves when the correct pressure is reached. The water used to top up the system contains oxygen and may cause corrosion in the system. For this reason, the system should be topped up as seldom as possible, at most once a year, when the heating system has been thoroughly bled and balanced.

If a joining must be loosened and then re-installed, for example when installing the substation or when replacing a filter unit, the joining gaskets should be exchanged to prevent leaks.

### 3 Product overview

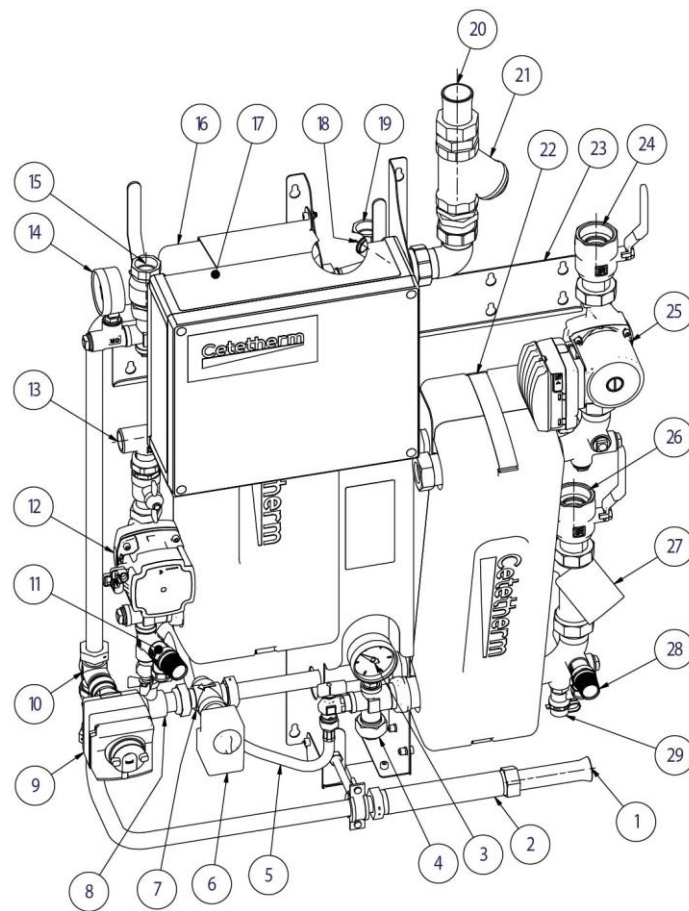

1	Primary return	16	Heat exchanger for domestic hot water
2	Adapter for energy meter, 1" x 130 mm or 1" x 190	17	Control cabinet
3	Pressure gauge for heating circuit	18	DH inlet temperature pocket
4	Connection, expansion vessel	19	DHW
5	Topping up	20	Primary supply
6	Actuator, heating circuit	21	Filter, primary in
7	Control valve, heating circuit	22	Heat exchanger for heating
8	Summer shut off valve *	23	Wall rail
9	Actuator, primary	24	Heating circuit, supply
10	Control valve for domestic hot water	25	Circulation pump heating
11	Safety valve for domestic hot water	26	Heating circuit, return
12	Circulation pump DHWC	27	Filer, heating circuit
13	DHWC	28	Safety valve for heating circuit
14	Pressure gauge, CW	29	Draining valve, heating supply
15	CW	*	Certain markets

**3.1 Measure sketch**

Example in the largest version. Width and depth vary with component selection.

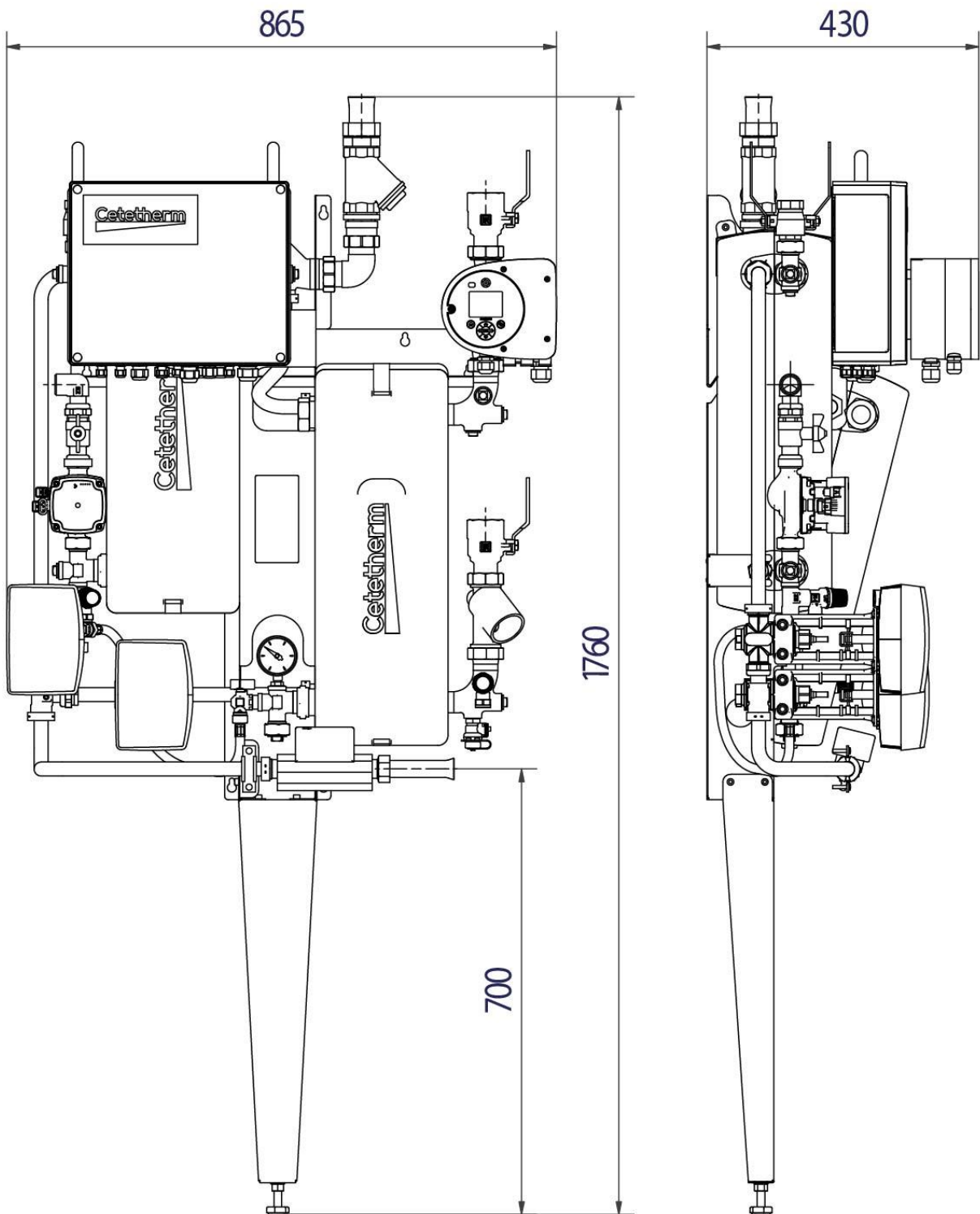

Width and depth vary with component selection.

Max & min width (mm)	Max & min depth (mm)	Max & min height (mm)
725	315	1760
865	430	1760



### 3.2 Wall rail – measurement

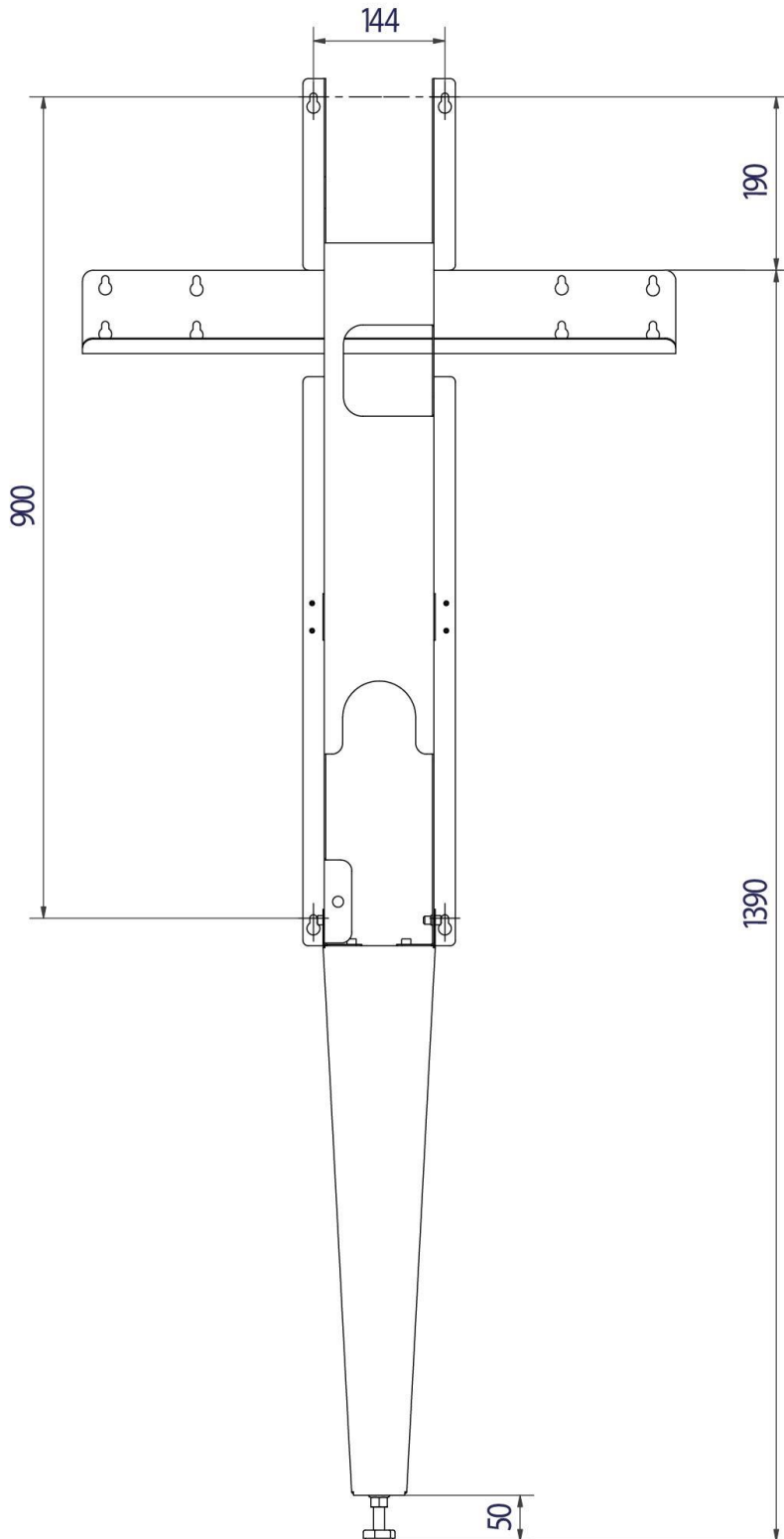

## 4 Mounting and installation

### 4.1 Unpacking

- Remove the transport packaging and check that the product has not been damaged in transport and that the consignment agrees with the specifications.
- When lifting the unit, take care not to apply stress to pipes and heat exchangers as this may weaken them. Lift in the frame, avoid lifting the unit by holding the heat exchangers. Use pallet lift where applicable, lifting strings should be attached in the frame.

**NOTE!** Risk of injury. The substation is very heavy.

- The pipes primary in, radiator supply and return, are angled down during transport. Put them in place and change gasket to enclosed.

### 4.2 Preparation

- Mini Select must be placed on a wall in upright position. Mount the unit using screws or bolts suitable for the material of the wall and for the weight of the unit.
- Choose a suitable installation area in accordance with official regulations. The unit may generate sounds during operation caused by pumps, regulators systems, flows etc. This should be taken in consideration during installation of the unit so that possible operational sounds affect the surroundings as little as possible.
- Cetetherm recommends that the unit is mounted on well-insulated walls, such as outer walls or on concrete walls.
- Check the applicable regulations of the primary heating supplier. Calculated and maximum differential pressure, see specification for the delivered Mini Select.
- Flush out the heating and hot water systems.

### 4.3 Mounting

- Mount the wall rail on the wall. Recommended distance is 1390mm between upper edge of wall rail to floor.

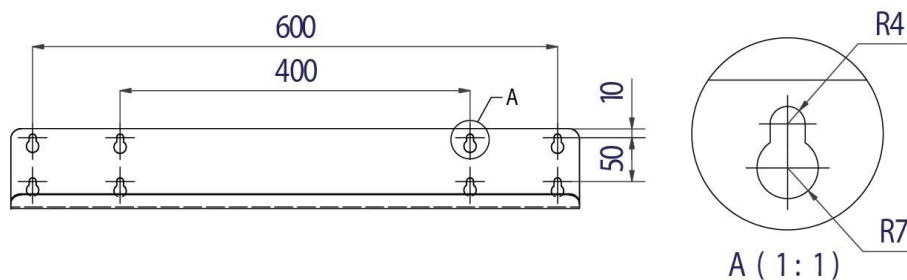

- Put the unit down and mount the floor support. Fasten the two internal screws first.

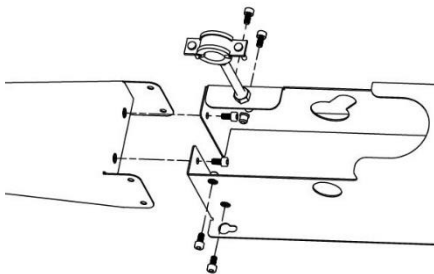

- Loosen the foot on the floor support, that it protrudes 70mm. Do not lock the foot.
- Raise the Mini Select and hang it on the wall rail. Make sure it hooks-up correctly.

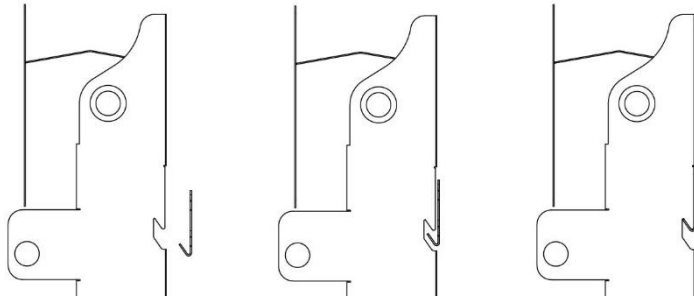

**NOTE!** Secure the unit against the wall in upper and lower edge, using the four the keyholes.

- Adjust the foot on the floor support and lock it.
- Place the unit that connections, control equipment and safety valves are easily accessible.
- Mount closing valves on primary supply and return. Closing valves is not included in Cetetherm delivery.
- Connect the pipe work to the connection points.
- When executing hot work on or close by the substation, all flammable components should be demounted and removed. Take rules and instructions regarding hot work into account.
- Connecting pipes shall be fixed in such a way that forces and movement from the pipework are not transferred to the unit.
- Pipes, even internal, shall be insulated according to standard when installing the unit.
- Drainage pipes from safety valves must be taken to floor gully.
- Energy meters must be installed at a prepared location, following the instructions of the energy supplier. If the provided measuring section is not approved in the heating network. A new separate measuring section must be built at place according to energy supplier.
- Retighten all connections, including those made at the factory. If connections need retightening after the installation has been taken into service, the system should be depressurised before retightening. **If the system is not depressurised before retightening, gaskets will be damaged.**
- Required expansion volume shall be installed and provided with adequate pre-charge before starting up.
- Remount plugs in drain valves after possible draining of circuit

#### 4.4 Adjustments and settings

- Open incoming cold-water supply and fill the service water and heating circuits, bleeding off any trapped air.
- Check the operation and opening pressures of the safety valves.
- Adjust the hot water temperature by having a hot water tap open at normal flow rate for a time. Check the hot water temperature in the controller. Make sure that the hot water/DHWC circuits and pumps are vented and that there is a hot water flow.

Adjust the hot water temperature according to controller manual.

**NOTE:** If the hot water temperature is measured after a hot water tap, make sure that no cold water is mixed up with the hot water while making this adjustment. E.g with a mixing valve.

## Cetetherm Mini Select

### Installation, service and operating instruction

- Start the heating circulation pump at the strongest flow setting during some minutes. The pressure must be minimum 1,0 bar in winter and 0,6 bar in summer.
- Set the pump capacity of the heating circulation pump and the DHWC-pump, if available. Use the lowest setting that manages the heating demand for the building and gives a DHWC temperature at approved level. Check the DHWC temperature, it should be at least 50°C
- Set time, date, and other necessary adjustment of the heating curve in the controller
- The property owner must be informed on how to operate, adjust, and maintain the unit. It is especially important to inform about the safety systems and the risks associated with the high pressure and temperature of the district heating system water supply.

#### **4.5 Dismantlement**

When the time comes for the substation to be dismantled and scrapped it must be disposed of in the correct manner in accordance with local or national regulations.

#### **4.6 Commissioning**

The controller has been set at the factory. If any function needs tuning, values can be changed. See the controller documentation. Initially, the commissioning process should be carried out with the factory settings. The parameter settings need tuning only if the substation does not function accordingly.

## 5 Schematic diagram, main components

Example of a Mini Select, see delivery documentation for specific details about delivered unit.

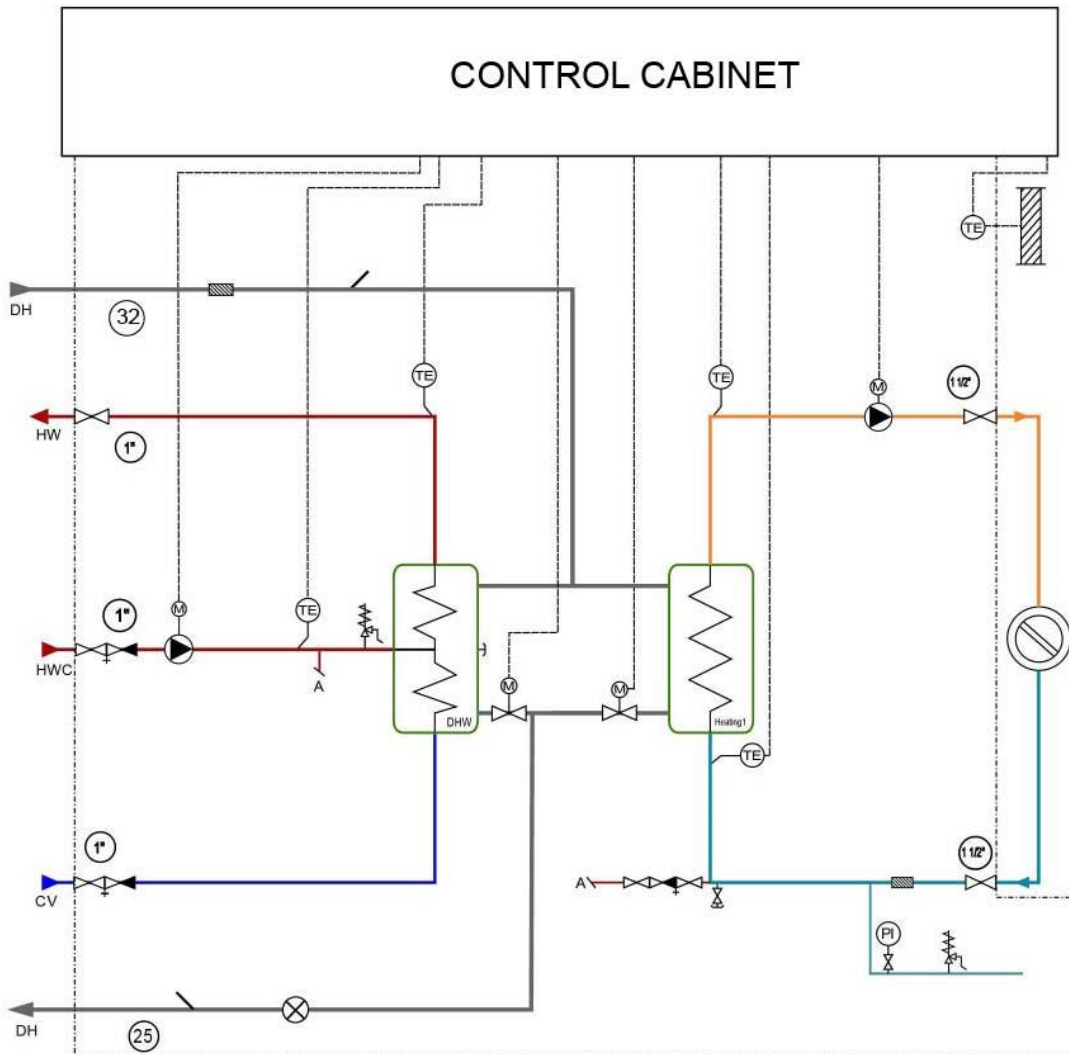

## 6 Electrical connections

### 6.1 General

The internal electrical connections done at the factory conforms to the rules for CE marking and has undergone electrical safety and function testing. The substation must be electrically connected by a qualified electrician.

### 6.2 Installation of the outdoor temperature sensor

An outdoor temperature sensor must be connected to compensate the supply temperature to current outdoor temperature. Remove any resistor. The resistor simulates an outdoor temperature of 0-10 ° until an outdoor temperature sensor is connected.



## 7 Service instruction



To avoid the risk of scalding, make sure that no-one draws any water while servicing the unit. Or close the primary supply temporary, that no overheated water can get out from the unit.



Grey marked service actions must be carried out by an authorized service technician.

**NOTE!** Make sure that the substation has been correctly installed.

### 7.1 Service instruction, tap water

#### 7.1.1 Tap water temperature low

Cause	Action
Primary supply to low	<b>Check available differential pressure and temperature at the district heating medium provider.</b> The temperature can be checked by means of the energy meter or contact the primary heating medium provider.
The heating control equipment needs to be adjusted.	<b>Check the parameter settings on the controller panel</b>
Filter for heating media clogged	<b>See 9.1 Cleaning the district heating filter</b>
Hot water valve and actuator does not work	<b>See 8.1 Check the function of the valve and actuator for hot water</b>

#### 7.1.2 Tap water temperature is too hot

Cause	Action
The heating control equipment needs to be adjusted.	<b>Check the parameter settings on the controller panel</b>
Hot water valve and actuator does not work.	<b>See 8.1 Check the function of the valve and actuator for hot water</b>

#### 7.1.3 Hot water temperature unstable

Cause	Action
Variation of differential pressure	<b>Check available differential pressure and temperature of primary heating.</b> The temperature can be checked by means of the energy meter or contact the primary heating medium provider.
Incorrect tap water settings	<b>Check the tap water settings via the controller.</b>
Filter for heating media clogged	<b>See 9.1 Cleaning the district heating filter</b>
DHW pump is not running	Check that the electrical power is on.
	<b>See 8.3 Check the circulation pump</b>

### 7.1.4 Noise in the DHWC system

Cause	Action
The DHWC pump capacity set too high	<b>Reduce the pump capacity</b> Reduce the pump capacity by choosing a lower setting.
Air in the DHWC pump	<b>Bleed the DHWC pump</b> Make sure the pump is running and set the pump to highest speed. When the pump has been vented, that is when the noise has ceased, set the pump per the recommendations.
DWHC pump motor or pump component damaged	<b>Change the DWHC pump</b> <i>See 9.4 Maintenance of components in the hot water circuit.</i>

## 7.2 Service instructions, heating circuit

### 7.2.1 Heating system temperature too high or too low

Cause	Action
The heating control equipment needs to be adjusted	<b>Check and adjust the heating curve.</b> See the controller instructions.
Filter for heating media clogged.	<i>See 9.2 Cleaning the heating circuit filter.</i>
Heating valve and/or actuator does not work.	<i>See 8.2 Check the heating actuator and valve function</i>

### 7.2.2 No heating

Cause	Action
Heating circulation pump not running.	<b>Check that the electrical power is on</b>
	<b>Check the set heating parameter at the controller.</b>
Air in the substation or in the heating circuit.	<b>Bleed the heating circuit pump.</b> Possible remaining air in the pump may cause noise. This noise ceases after a few minutes run time.
Filter for heating media or heating circuit clogged.	<i>Se 9.2 Cleaning the heating circuit filter.</i>

### 7.2.3 Noise in the radiator system

Cause	Action
The heating pump capacity set too high.	<b>Reduce the pump capacity.</b> Reduce the level by choosing a lower output setting on the pump. The lowest setting is the most economical.
Air in the heating pump	<b>Bleed the heating pump.</b> Possible remaining air in the pump may cause noise. This noise ends after a few minutes run time
Heating pump motor or pump component damaged.	<b>Change the heating pump</b> <i>See 9.3 Maintenance of components in the heating circuit</i>



**7.2.4 Heating system often need topping up**

<b>Cause</b>	<b>Action</b>
Leaks in the substation or in the system	<p><b>Check the substation and the system for leaks.</b> Leaks in the heating system or in the unit cause pressure drop. Contact a service technician to repair any leaks on the substation</p>
The heating system safety valve is leaking or does not work.	<p><b>Check the heating system safety valve.</b> Check that the safety valve is not leaking and that it works properly. Check the safety valves' function by turning the wheel/knob until water runs out of the valve's waste pipe and then quickly close the valve.</p>
The expansion vessel cannot handle the systems volume changes	<p><b>See 8.4 <i>Check the volume take-up and pressure equalizing of the expansion vessel</i></b></p>

## 8 Service actions for the installer

### 8.1 Check the function of the valve and actuator for hot water



Service actions must be carried out by an authorized service technician.



Close the shutoff valves for the **Primary supply** and **Primary return** together with the **cold** and **hot water**.



After finishing repair, open the shutoff valves. Start with **Primary supply** and then the **return** line, to avoid pollutions in the system. Open the valves slowly to avoid pressure surges.

1. Start by checking if the actuator can be manover via controller service menu. If not, disconnect the power feed to the substation.
2. See actuator documentation and try manually to open and close the actuator.
3. Before testing the hot water valve, remove the actuator. See actuator documentation and dismount it from the valve.
4. Carefully press the valve's spindle with a tool and check the valve's travel and spring back.  
**NOTE: The valve may be very hot.**
5. Remount the actuator on the valve. Order new parts if necessary.

### 8.2 Check the heating actuator and valve function



Service actions must be carried out by an authorized service technician.

1. Start by checking if the actuator can be manover via controller service menu. If not, disconnect the power feed to the substation.
2. See actuator documentation and try manually to open and close the actuator.
3. Check the flow using the energy meter while test-running actuator.  
If no energy meter is available, disconnect the heating actuator from the valve.
4. Carefully press the valve's spindle with a tool and check the valve's travel and spring back.  
**NOTE: The valve may be very hot.**
5. Remount the actuator on the valve. Order new parts if necessary.

### 8.3 Check the circulation pump

If the pump fails to start after stopping, try to start it at the highest setting.



Service actions must be carried out by an authorized service technician.



Disconnect the power feed to the pump by pulling off the connector before carrying out this task. If the current is on when you use a screwdriver to assist the pump to start, the screwdriver may be wrenched out of your hand when the pump starts.

1. Depending on pump model, the pump can be started by removing the pump motor end nut and helping the pump to start with the aid of a screwdriver in the notch on the engine shaft.
2. If possible, use a short screwdriver. If the pump is difficult to access, disconnect the heating actuator.
3. Connect the power feed to the pump and try to start again.

### 8.4 Check the volume take-up and pressure equalizing of the expansion vessel



The expansion vessel is not a part of the delivery from Cetetherm. The expansion vessel volume should be fitted to the heating systems volume and temperature.

Check that the expansion vessel has adequate pre-charge and possible leakage.





Alternatively, the system's total volume of water may be too high, i.e. the volume changes are too large for the expansion vessel. If so, add extra expansion volume.

## 9 Maintenance and repairs

When carrying out repairs, please contact your local service partner.



	Before starting out repairs always close the correct shutoff valves.
	When dismantling a component there will be water coming out, hot and under pressure.

### 9.1 Cleaning the district heating filter

	Service actions must be carried out by an authorized service technician.
	The temperature and the pressure of the district heating water are very high. Only qualified technicians can work with the district heating substation. Incorrect operation may cause serious personal injury and result in damage to the building.
	Before starting out repairs close the <b>Primary supply</b> and <b>Primary return</b> shutoff valves.
	After finishing repair, open the shutoff valves. Start with <b>Primary supply</b> and then the <b>return</b> line, to avoid pollutions in the system. Open the valves slowly to avoid pressure surges.





1. Disconnect the power feed to the substation.
2. Close the shut-off valves.
3. Use a wrench and release the filter cover and remove the cartridge.
4. Clean the filter with water and refit the cartridge. Screw the filter cover with a momentum of 10-20 Nm.
5. Open the shutoff valves and connect the power feed to the substation

### 9.2 Cleaning the heating circuit filter

	Service actions must be carried out by an authorized service technician.
	Before starting out repairs, close the shutoff valves <b>Primary supply</b> , <b>Primary return</b> , <b>heating supply</b> and <b>heating return</b> . Release the pressure using the heating circuit safety valve.
	After finishing repair, fill up the circuit and vent. Then open the shutoff valves, start with <b>Primary supply</b> and then the <b>return</b> line, to avoid pollutions in the system. Then open <b>heat return</b> and then <b>supply</b> . Open the valves slowly to avoid pressure surges.





1. Disconnect the power feed to the substation.
2. Close the shut-off valves.
3. Use a wrench and release the filter cover and remove the cartridge.
4. Clean the filter with water and refit the cartridge. Screw the filter cover with a momentum of 10-20 Nm.
5. Fill up the heating circuit using the topping up valve, vent the heating circuit.
6. Open the shutoff valves and connect the power feed to the substation.

### 9.3 Maintenance of components in the heating circuit

	Service actions must be carried out by an authorized service technician.
	Disconnect the power feed to the substation.
	Before starting out repairs, close all shutoff valves. Release the pressure using the heating circuit safety valve.
	After finishing repair, fill up the circuit and vent. Then open the shutoff valves, start with <b>Primary supply</b> and then the <b>return</b> line, to avoid pollutions in the system. Then open <b>heat return</b> and then <b>supply</b> . Open the valves slowly to avoid pressure surges.

See separate manual for each component.

### 9.4 Maintenance of components in the hot water circuit

	Service actions must be carried out by an authorized service technician.
	Before starting out repairs, close the shutoff valves <b>Primary supply, Primary return, cold-water and hot water</b> . Note the setting of the balancing valve, then close it. Release the pressure using the DHWC safety valve.
	After finishing repair, fill up the hot water circuit and vent. Open the shutoff valves, start with <b>Primary Supply</b> and then <b>Primary return</b> , to avoid pollutions in the system. Open the valves slowly to avoid pressure surges.
	Check the DHWC circulation.

See separate manual for each component.

Cetetherm AB  
Fridhemsvägen 15  
372 38 Ronneby – Sweden  
[www.cetetherm.com](http://www.cetetherm.com)

**Cetetherm**  
**NIBE** GROUP MEMBER