

## Installation, service and operating instruction Cetetherm Mini Plus SR144

District heating HIU for single-family houses and multi-family buildings (1 to 12 apartments)

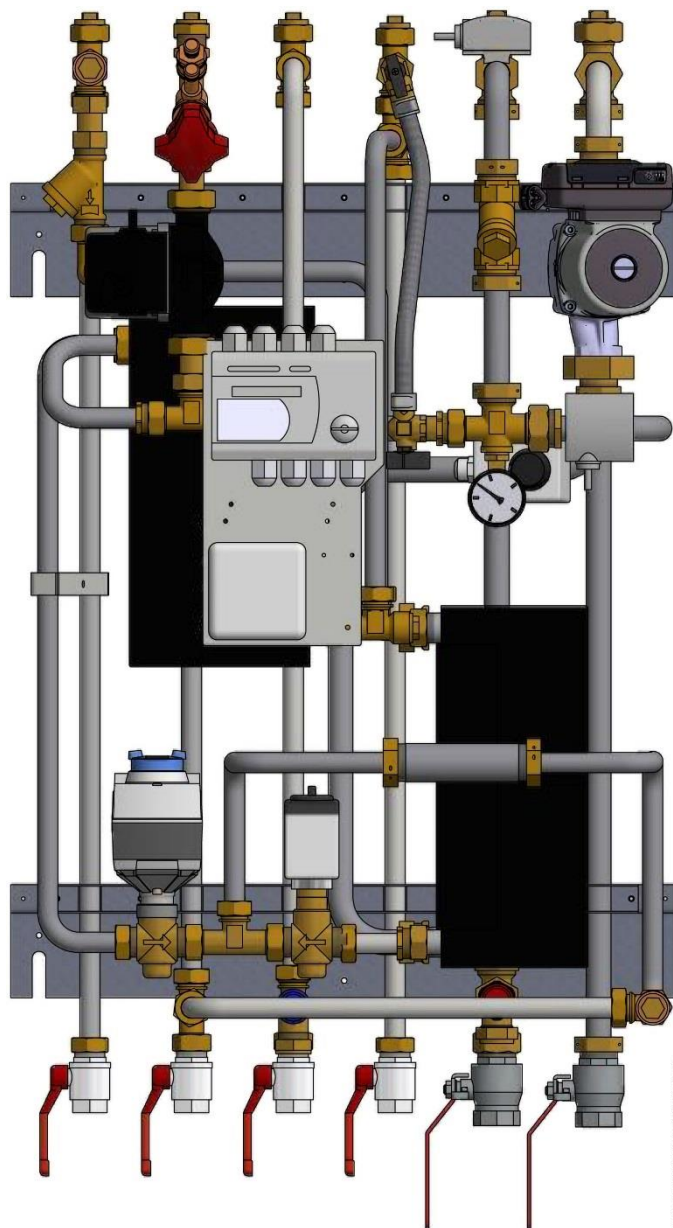

**For additional online information and manual:**

URL address:

<https://www.cetetherm.com/miniplus>

QR-code:



Cetetherm District heating substation				
Cetetherm Mini Plus...				
Main No. xxxxxx				
Part No. xxxxxx				
Main Year 2018				
		Primary	Heating	DHW
Design pressure	PSI	015	015	015
Design temp	TS °C	0120	090	090
Leakage test	bar	2	2	2
Volume	V L	1.011.57	1.05	1.62
Safety valve release press	bar	2.5	9	-
Capacity	kW	40	58	-
Temp range	°C	100-63/80-80 55-22/13-55		
Electrical conn.	230V, 1-			
Fluid group 2, PED 2014/68/EU art 4.3				
Manufacturer Cetetherm AB, Rönneby, Sweden				

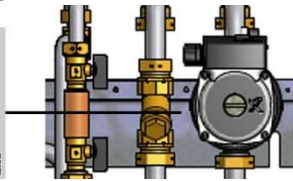

This manual is published by Cetetherm.

Cetetherm can without further notice make changes and improvements to the content in this manual if it is necessary due to printing mistakes, wrong information or changes in the hardware or software.

All these types of changes will be included in future release of the manual.

# Contents

<b>1</b>	<b>General information.....</b>	<b>3</b>
1.1	Comfort.....	3
1.2	Installation.....	3
1.3	Long-term security.....	3
1.4	CE-marking.....	3
1.5	Information about the document.....	3
1.6	General warnings.....	4
<b>2</b>	<b>Operating instructions.....</b>	<b>5</b>
2.1	Operation.....	5
2.2	Safety equipment/inspection.....	5
<b>3</b>	<b>Product overview.....</b>	<b>6</b>
<b>4</b>	<b>Installation.....</b>	<b>7</b>
4.1	Unpacking.....	7
4.2	Preparation.....	7
4.3	Mounting.....	7
4.4	Mounting options.....	8
4.5	Adjustments and settings.....	8
4.6	Dismantlement.....	8
4.7	Commissioning advice.....	8
<b>5</b>	<b>Measure sketch Mini Plus.....</b>	<b>9</b>
<b>6</b>	<b>Operating the control panel RVD144.....</b>	<b>10</b>
6.1	Choosing operating modes.....	10
6.2	Manual operation.....	11
6.3	Set point knob for adjusting the room temperature.....	11
6.4	Information on the LCD display.....	11
6.5	Buttons for settings and adjustment.....	12
6.5.1	Buttons.....	12
6.5.2	Block skip function.....	12
6.6	Setting the temperatures in the heating system.....	12
6.7	Setting the DHW set point temperature.....	12
6.8	Heating Curve.....	13
6.9	Adjusting the heat curve/room temperature.....	14
6.10	Setting the clock and date.....	14
6.11	Setting or changing the heat program.....	14
6.12	Reading of temperatures, actual value.....	14
<b>7</b>	<b>Settings on the heating engineer's level.....</b>	<b>15</b>
7.1	Level settings and access rights.....	15
7.2	Plant configuration.....	15
7.3	Pump kick.....	15
7.3.1	Changing between summer and winter time.....	15
7.4	Spaceheating.....	16
7.5	Actuator heating circuit.....	16
7.6	D.h.w. heating.....	16
7.7	Test and display.....	16
7.7.1	Sensor test.....	17
7.7.2	Relay test.....	17
7.7.3	Resetting the heating engineer level.....	17
7.7.4	Software version.....	17
7.8	Reset end-user level.....	18
7.9	ModBus communication.....	18
<b>8</b>	<b>Troubleshooting.....</b>	<b>19</b>
8.1	Standard values and fault indication on the RVD144.....	19
8.2	Fault codes on the RVD144.....	19
8.2.1	Fault in heating control system.....	19

<b>9</b>	<b>Electrical installation</b> .....	<b>20</b>
9.1	Installing the outdoor temperature sensor .....	20
<b>10</b>	<b>Electrical circuit diagram</b> .....	<b>21</b>
<b>11</b>	<b>Schematic diagram, main components</b> .....	<b>22</b>
<b>12</b>	<b>Pump settings and pump performance</b> .....	<b>23</b>
12.1	General .....	23
12.2	DHWC-pump Grundfos UPM3 DHW 15–70 CIL3, capacity .....	23
12.3	Heating circuit pump Grundfos UPM3 Auto 15–70 .....	24
12.3.1	Alarm status .....	24
12.3.2	Changing the control mode .....	25
12.3.3	Pump curve proportional pressure mode 2, PP2 .....	26
12.4	Heating circuit pump Grundfos UPML 25-105 180 Auto, settings and capacity .....	27
12.4.1	Changing pump curve setting .....	28
<b>13</b>	<b>Fault finding pump</b> .....	<b>29</b>
13.1	Fault finding UMP3 pump .....	29
<b>14</b>	<b>Service instructions</b> .....	<b>30</b>
14.1	Tap water service instructions .....	30
14.1.1	Tap water temperature too low .....	30
14.1.2	Tap water temperature too high .....	30
14.1.3	Hot water temperature unstable .....	31
14.1.4	Noise in the DHWC system .....	31
14.2	Heating system service instructions .....	32
14.2.1	Heating system temperature too high or too low .....	32
14.2.2	No heating .....	33
14.2.3	Heating system often needs topping up .....	34
14.2.4	Heating temperature unstable .....	34
14.2.5	Noise in the radiator system .....	34
<b>15</b>	<b>Service actions for the service technician</b> .....	<b>35</b>
15.1	Check the function of the valve for hot water .....	35
15.2	Check the heating actuator and valve function .....	36
15.3	Check the VVC pump .....	36
15.4	Run the pump manually .....	37
15.5	Check the volume take-up and pressure equalizing of the expansion vessel .....	37
<b>16</b>	<b>Maintenance and repairs</b> .....	<b>38</b>
16.1	Cleaning the district heating filter .....	38
16.2	Cleaning the heating circuit filter .....	38
16.3	Change the complete DHWC pump or pump components .....	39
16.4	Change the complete heating pump or pump components .....	40
16.5	Change the heating supply temperature sensor .....	40
16.6	Change the outdoor temperature sensor .....	41
16.7	Change the heating actuator .....	41
16.8	Change the heating valve .....	42
16.9	Change the hot water valve .....	43
16.10	Change the hot water actuator .....	43
16.11	Change the DHWC check valve .....	44
16.12	Change the expansion vessel .....	44
<b>17</b>	<b>Options</b> .....	<b>45</b>
17.1	Safety thermostat .....	45
<b>18</b>	<b>Operating Data and performance</b> .....	<b>46</b>
18.1	Operating data Mini Plus CB30-60H .....	46
18.2	Operating data Mini Plus CB18-54H .....	46

# 1 General information

Cetetherm Mini Plus is a complete, ready-to-install heating network HIU for heating and hot water. It is designed for buildings with a primary connection to a heating network. Cetetherm has years of experience in heating network technology and has developed Mini Plus with well-planned pipe work and with all components easily accessible for inspection and possible future servicing.

## 1.1 Comfort

Mini Plus has fully-automatic temperature control for heating and hot water. The heating is controlled in relation to desired room temperature. The hot water is controlled and maintained at the desired temperature.

## 1.2 Installation

Before installation this manual must be read.

Well planned pipe work and readymade electrical wiring make installation very simple. A pre-programmed controller and plug-and-socket connection provide further simplification, so that the HIU can be started without delay. The Mini Plus is designed for hanging on the wall.

Mini Plus is supplied fully wired. The wiring conforms to the applicable rules for CE marking and has undergone electrical safety testing and function testing. For permanent installation, the HIU must be connected via an all-pole isolator switch.

The HIU must be connected to a grounded wall socket

## 1.3 Long-term security

All the plates and pipes in the heat exchanger are made of acid-resistant stainless steel for long life. All components are closely matched and carefully tested for function in accordance with quality assurance system ISO9001:2015. For future servicing requirements, all components are easily accessible and individually replaceable.

## 1.4 CE-marking









Mini Plus is CE-marked to certify that the HIU conforms to international safety regulations. To maintain the validity of the CE marking, only identical replacement parts must be used.

## 1.5 Information about the document

All pictures in this document are general images.

Mini Plus is available in different models and levels of equipment.

## 1.6 General warnings

	The installation work must be carried out by an authorized installation contractor. Before the system is taken into operation, it must be pressure tested in accordance with relevant regulations.
	The temperature and the pressure of the district heating water are very high. Only qualified technicians can work with the district heating HIU. Incorrect operation may cause serious personal injury and result in damage to the building.
	If the hot water temperature is set too high, people may be scalded. If the hot water temperature is set too low, unwanted bacteriological growth may occur in the hot water system. This can result in serious personal injury.
	Parts of the HIU may get very hot and should not be touched.
	Before the HIU is connected to the electrical supply, make sure that the secondary heating system is topped up with water. Starting up the system without water will damage the circulation pump.
	The HIU comes prepared with an electrical plug to be connected to the main supply. The strain relief clips of the cable must be fitted to avoid damage. If necessary, the plug-and-socket connection can be replaced with a permanent installation with an all-pole isolator switch. This must be carried out by a qualified electrician.
	When starting up the district heating HIU, to avoid the risk of scalding, make sure that no-one draws any hot water until the hot water temperature has been adjusted.
	Start district heating circulation by first opening the valve in the <b>district heating supply</b> and then <b>return</b> lines, to avoid pollutions in the system. Open the valves slowly to avoid pressure surges. Do the same way with the heating circuit, first open the valve for <b>heating return</b> then <b>supply</b> .
	Do not shut of the electrical supply to the operator control panel. This will damage the circulation pump, valves, actuators etc.

## 2 Operating instructions

### 2.1 Operation

The temperature and pressure of the incoming heating network water from the culvert network are very high. For this reason, only the heat from this water is used. The heating network water does not enter the heating and hot water systems of the building.

The heat from the heating network water is transferred to the heating and hot water systems of the building in the heat exchangers. The heat is transferred through thin plates of acid-resistant stainless steel which keep the heating network water separate from the systems in the building.

Mini Plus has automatic temperature control for heating and hot water. The heating circuit is controlled in relation to outdoor temperature and/or desired room temperature by means of a controller and temperature sensor. When no heat is needed, the circulation pump in the heating circuit stops automatically, but is started regularly to make sure that it does not seize up during long idle periods. The hot water temperature is controlled by a temperature control system which is set to about 55 °C.

After adjustment, the Mini Plus operates completely automatically. However, in hard water areas it is advisable to be attentive and to remedy any faults in good time if the temperature of the hot water is too high, otherwise the risk of lime deposits in the heat exchanger may increase.

### 2.2 Safety equipment/inspection

- Daily inspection to check for leaks from pipes or components.
- Weekly inspection to make sure that the operation of the heating and hot water control systems is stable and that the temperature does not fluctuate. Temperature variation causes unnecessary wear of valves, actuators and heat exchangers.
- Every three months check the safety valves and the pressure in the heating system.

To check the operation of a safety valve, turn its wheel/knob until water escapes from the valve, then close the wheel/knob quickly. Occasionally a safety valve may open automatically to release excess pressure. After a safety valve has been open it is important that it closes properly and does not drip.

The heating system is topped up via the heating filler valves, see [14.2 Heating system service instructions](#).

Be sure to close the valves when the correct pressure is reached. The water used to top up the system contains oxygen and may cause corrosion in the system. For this reason, the system should be topped up as seldom as possible, at most once a year, when the heating system has been thoroughly bled and balanced.

Hot water temperature in apartments or one family houses can be set to about 55°C. If the temperature is set too high, there is a risk of scalding. Setting the hot water temperature too low may result in unwanted bacteriological growth in the hot water system.

For setting and (if necessary) fine adjustment of the heating and hot water temperatures, see [chapter 6](#).

### 3 Product overview

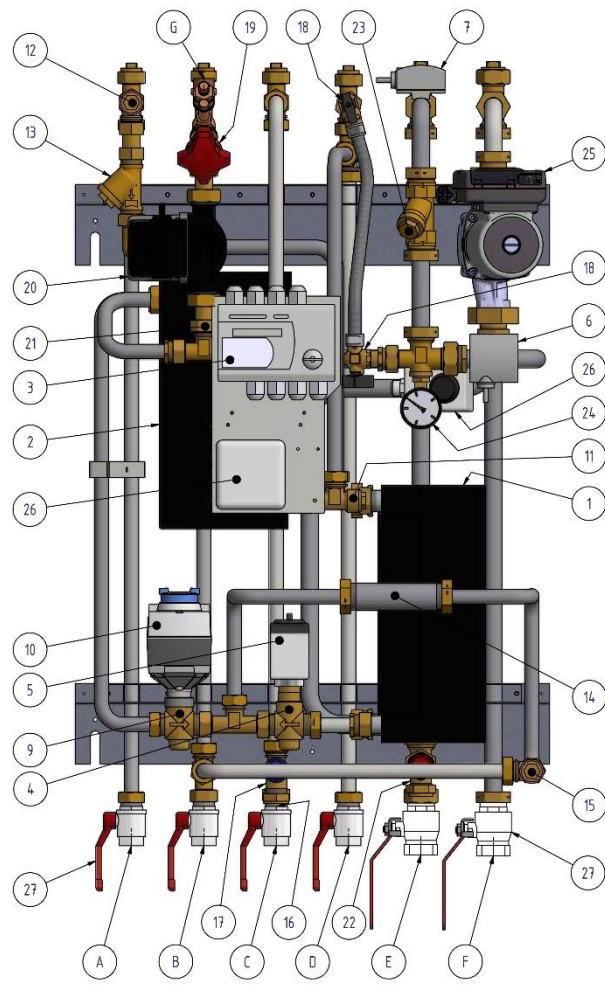

Picture 1

1	Heat exchanger for heating	18	Topping up heating
2	Heat exchanger for domestic hot water	19	Balancing valve DHWC
3	Operator control panel with connection box	20	Circulation pump DHWC
4	Control valve, heating circuit	21	Check valve for DHWC
5	Actuator, heating circuit	22	Safety valve for heating circuit
6	Supply temperature sensor, heating circuit	23	Filter for heating circuit
7	Return temperature sensor, heating circuit	24	Pressure gauge for heating circuit
8	Outdoor temperature sensor (not in picture)	25	Circulation pump heating
9	Control valve for domestic hot water	26	Safety thermostat (option)
10	Actuator domestic hot water	27	Shutoff valves
11	Supply temperature sensor, domestic hot water	A	District Heating Supply
12	Temperature sensor connection, DH supply	B	District Heating Return
13	Filter for district heating supply	C	CW
14	Adapter for energy meter	D	DHW
15	Temperature sensor connection, DH return	E	Heat, Return
16	Check valve for cold water (not in picture)	F	Heat, Supply
17	Safety valve for domestic hot water	G	DHWC



## 4 Installation

### 4.1 Unpacking

- Remove the transport packaging and check that the product has not been damaged in transit and that the consignment agrees with the specifications.
- When lifting the unit, take care not to apply stress to pipes and heat exchangers as this may weaken them. Avoid lifting the unit by holding the heat exchangers.

**Note:** Risk of injury lifting heavy objects.

### 4.2 Preparation

- Choose a suitable installation area in accordance with official regulations. The system may generate sounds during operation caused by pumps, regulators systems, flows etc. This should be taken into consideration during installation of the unit, so that possible operational sounds affect the surroundings as little as possible. This means that the system should be installed on well-insulated walls, such as outer walls or on concrete walls.
- Check the applicable regulations of the district heating supplier. The available differential pressure should be at least 100 kPa and at most 600 kPa. Where the differential pressure is higher, a differential pressure controller should be added to the installation.
- Flush out the heating and hot water systems.

### 4.3 Mounting

- Mount the HIU on the wall using four screws or bolts suitable for the material of the wall and for the weight of the unit. The unit may be mounted at any height on the wall, 1500 – 1800 mm from floor to keyhole fixing may be taken as a guide. The hole pattern for screws/bolts and the piping connection measures is shown in [5 Measure sketch Mini Plus](#).
- Install enclosed check valve for cold water in cold water pipe.

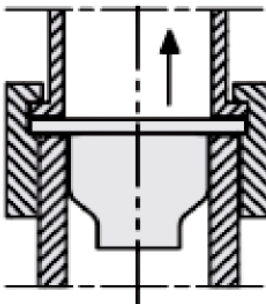

Picture 2; Installation of check valve in cold water pipe

- Connect the pipe work to the connection points. Use the enclosed shutoff valves with flat contact face.
- Drainage pipes from safety valves must be taken to floor gully.
- Energy meters must be installed at a prepared location, replacing a gauge block, or following the instructions of the energy supplier.
- Retighten all connections, including those made at the factory. If connections need retightening after the installation has been taken into service, the system should be depressurised before retightening. If the system is not depressurised before retightening, gaskets will be damaged.
- Mount the outdoor temperature sensor on the north side of the building, 2 metres above the ground, or higher. For installation of the outdoor temperature sensor, see [9.1 Installing the outdoor temperature sensor](#).

#### 4.4 Mounting options

- If the HIU is connected to a system sensitive to high temperature or to a low temperature system, for example floor heating, a safety thermostat must be mounted and activated before start up. See chapter [17.1 Safety thermostat](#).

#### 4.5 Adjustments and settings

- Allow 5 minutes for the controller start up sequence and to regain functionality after a power cut.
- Open incoming cold-water supply and fill the service water and heating circuits, bleeding off any trapped air.
- Check the operation and opening pressures of the safety valves.
- Now adjust the hot water temperature by having a hot water tap open at normal flow rate for a time. Measure the temperature at the draw-off point with a thermometer. The temperature should be approximately 55°C. It takes about 20 seconds to get stable tap water temperature. See [14.1 Tap water service instructions](#) for adjusting hot water temperature.

**NOTE:** Make sure that no cold water is mixed with the hot water while making this adjustment.

- Start the heating circulation pump with the highest output setting. Let the heating system heat up and bleed the system again, see [14.2 Heating system service instructions](#). After final bleeding, the pressure should not be less than 1.0 bar in winter and not less than 0.6 bar in summer.
- Set the pump capacity of the heating circulation pump according to the pressure head diagram. Use the lowest setting that manages the heating demand for best electrical efficiency.
- Make any necessary adjustment of the heating curve of the control and regulating equipment. Information about the controller can be found later in this instruction.
- Set the time and date on the operator control panel.
- The property owner must be instructed in the operation, setting and care of the unit. It is particularly important to provide information about the safety systems and about hazards that may arise in relation to the high pressure and temperature of the district heating water.

#### 4.6 Dismantlement

When the time comes for the HIU to be dismantled and scrapped it must be disposed of in the correct manner in accordance with local or national regulations.

#### 4.7 Commissioning advice

The controller has been set at the factory. If any function needs tuning, values can be changed with reference to this manual for parameter setting. Initially, the commissioning process should be carried out with the factory settings. The parameter settings need tuning only if the district heat terminal does not function accordingly.

## 5 Measure sketch Mini Plus

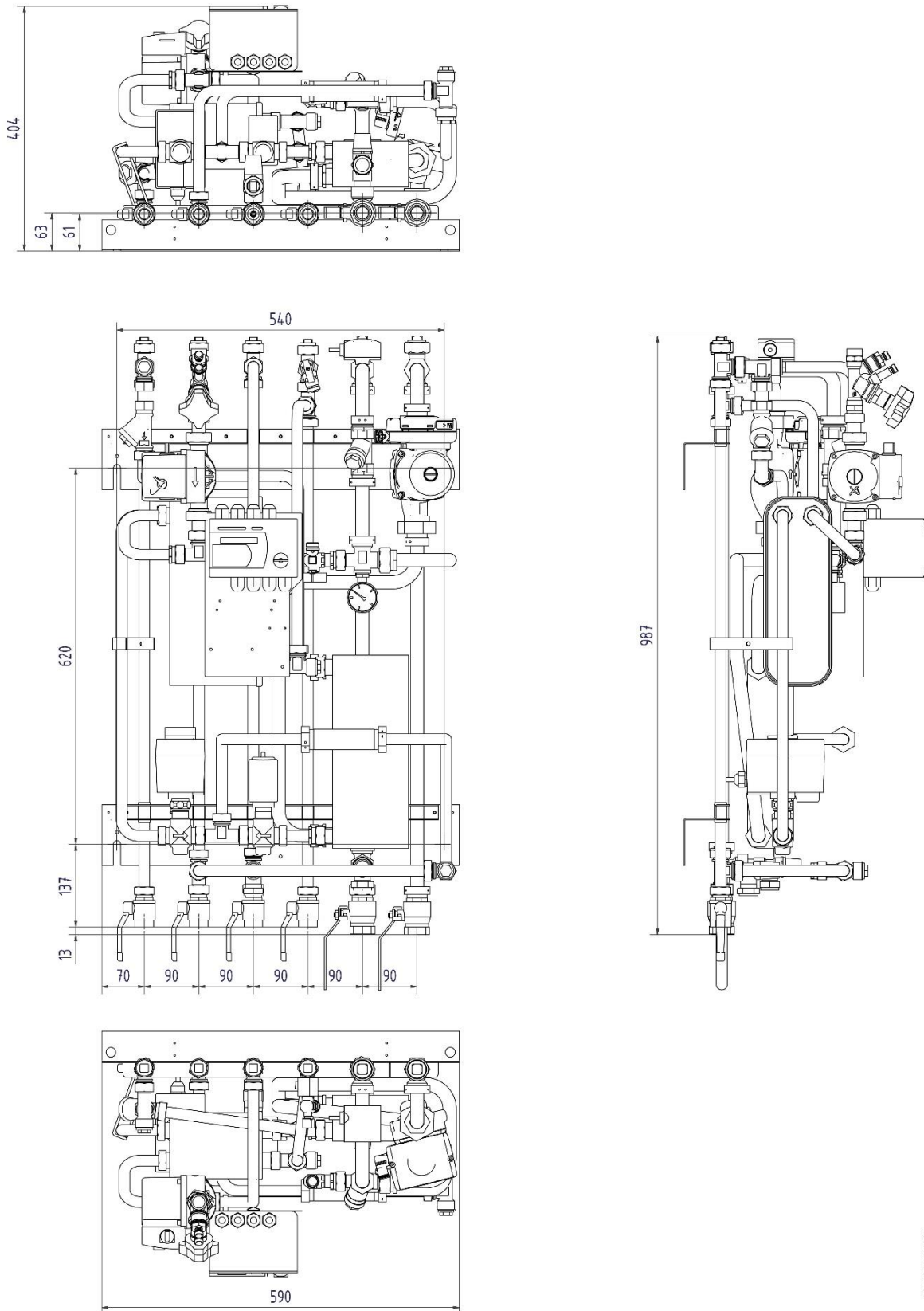

Picture 3

0720001\_03\_001\_P104\_RVD144

## 6 Operating the control panel RVD144

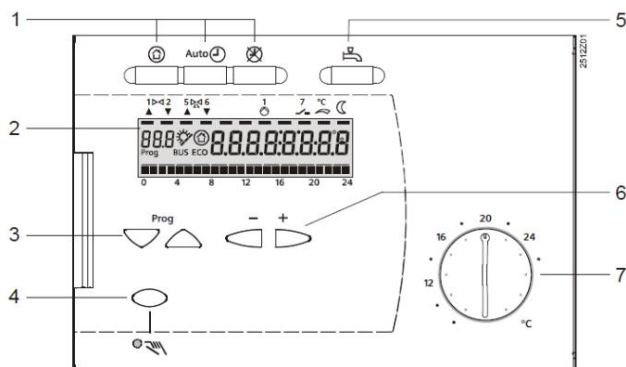

Picture 4

1. Operating mode buttons
2. Display (LCD)
3. Buttons for selecting operating lines
4. Button for manual operation ON/OFF
5. Button for d.h.w. heating ON/OFF
6. Buttons for making readjustments of values
7. Adjusting knob for nominal room temperature set point

### 6.1 Choosing operating modes

The following operating mode buttons are available:

- 3 buttons for selecting the heating circuit's operating mode
- 1 button for d.h.w. heating

The required operating mode is activated by pressing the respective button. Each of the buttons contains an LED that will light to indicate the currently active operating mode.



#### Stand-by

- Heating operation OFF
- Frost protection is ensured



#### Automatic operation

- Automatic heating operation, changeover between nominal and reduced temperature according to the time program
- ECO function with needs oriented connection and disconnection of the heating system as a function of the outdoor temperature and the building's heat storage capacity. ECO-saving automatic closes the control valve and stops the heating pump. The pump is run regularly.
- Frost protection is ensured



#### Continuous operation

- Heating operation with no time program
- Heating to the room temperature adjusted with the setting knob
- Frost protection is ensured
- ECO-saving automatic is not active and the heating pump runs continuously.



#### D.h.w. heating ON/OFF

- ON (button lit):  
D.h.w. is heated independently of the heating circuit's operating mode and control
- OFF (button dark):  
No d.h.w. heating; circulating pump switches off, frost protection is ensured

## 6.2 Manual operation

Manual operation is activated by pressing a button. It is indicated by an LED. At the same time, the LEDs in the operating mode buttons extinguish. Manual operation is quit by pressing the same button again or by pressing any of the operating mode buttons.



### Manual operation

- No operating mode
- Heating circuit pump and d.h.w. pumps are running.
- The control valve in the primary circuit can be manually operated with the setting buttons, or with the handle on the valve



The control valve for domestic hot water should **NEVER** be operated by hand.

## 6.3 Set point knob for adjusting the room temperature

The knob is used to make manual adjustments of the nominal room temperature set point.

Its scale gives the room temperature in °C.

Turning the knob produces a parallel displacement of the heating curve, the room temperature will increase or decrease according to the room temperature scale on the adjusting knob.

## 6.4 Information on the LCD display



If the bar is alight under...	Explanation
	Heating is maintained at normal set point temperature (preset on adjusting knob)
	Heating is maintained at lowered temperature
The display shows	Explanation
	Heating is maintained at freezing protection temperature
ECO	No heating is needed. Pump stop activated
┌ or ┘	A limit function is active
	Hot water with solar
BUS	The controller is connected to ModBus

## 6.5 Buttons for settings and adjustment



The entry or readjustment of all setting parameters, activation of optional functions and reading of actual values and states is made according to the operating line principle. An operating line with its number is assigned to each parameter, actual value and function that can be selected.

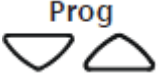

One pair of buttons is used to select an operating line and one pair to readjust the display.

### 6.5.1 Buttons

Buttons	Procedure	Effect
Line selection buttons	 Press	Selects the next lower or higher operating line
Setting buttons	 Press	Decreases or increases the displayed value



The set value will be adopted

- when selecting the next operating line, that is, by pressing a line selection button  or , or
- by pressing an operating mode button

If entry of --.- or --:-- is required, setting button  or  must be pressed until the required display appears. Then, the display shows constantly --.- or --:--.

### 6.5.2 Block skip function

The operating lines are grouped as blocks. To select an individual operating line in a block as quickly as possible, the other lines can be skipped. This is made by using two button combinations:

Procedure	Effect
Keep  depressed and press  or  .	Selects the next higher or lower block

## 6.6 Setting the temperatures in the heating system

1. Use the setting knob for the required temperature set point.  
The setting will be active:
  - On automatic operation during the heating periods that have been entered into the heating program
  - Constantly on continuous operation
2. Use the buttons to set other temperatures and the required control curve as follows:

Line	Function, parameter	Unit	Factory setting	Range
1	Current nominal room temperature set point		Display function	
2	Reduced room temperature set point	°C	18	variable*
3	Frost protection/holiday mode set point	°C	8	8...variable*
5	Heating curve slope		1,25	2,5...4,0

\* variable setting

## 6.7 Setting the DHW set point temperature

Line	Function, parameter	Unit	Factory setting	Range
41	DHW normal set point	°C	55	50°C - 65°C

## 6.8 Heating Curve

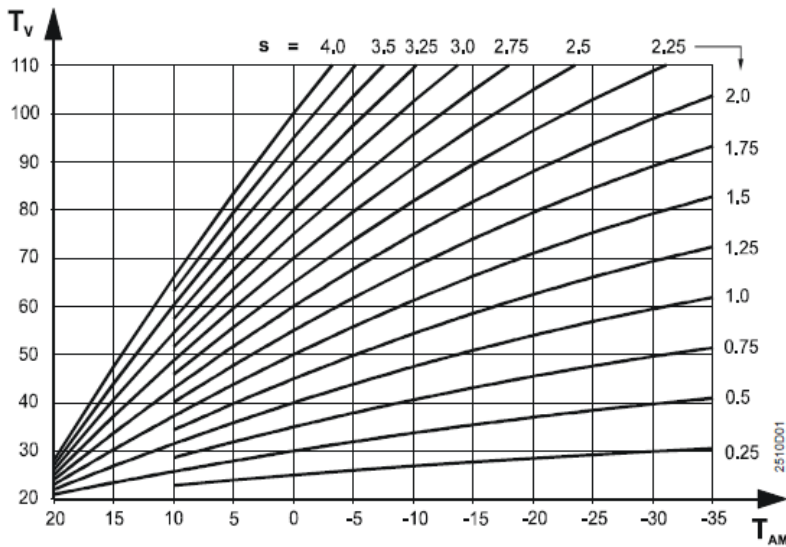

Picture 5

S Slope  
 TAM Composite outside temperature  
 TV Supply temperature

Set the correct heating curve based on the supply temperature and Composite Outside Temperature (COT).

Picture 5 shows examples of different heating curves that can be set and adjusted according to COT and the supply temperature.

It is possible to choose a curve that lies between the default heating curves.

Default value is 1.25 for the heating curve, this fits most new houses.

Adjust the slope of the heating curve on the program line .

The graph for heating curves is specific to the building and must be adjusted individually during the first heating season.

**NOTE!** For a house with under floor heating, the value in the graph should be around 0.5. Always check with the under-floor heating supplier.

With weather-compensated supply temperature, the supply temperature set point follows the heating curve.

## 6.9 Adjusting the heat curve/room temperature

**Mainly in mild weather:**

Use the adjusting knob to adjust the room temperature .

**Mainly in cold weather:**

Adjust the slope of the heating curve on the program line .

- The room temperature is too high: Lower the slope by about 0.5.
- The room temperature is too low: Increase the slope by about 0.5.

**Mainly at night:**

Adjust the temperature for lowered set point on the program line .

Wait for two days after every room temperature adjustment to allow the control system to stabilize.

## 6.10 Setting the clock and date

Line	Function, parameter	Unit	Factory setting
13	Time of day	hh:mm	(00:00...23:59)
14	Weekday	d	Display function
15	Date	dd.MM	(01.01...31.12)
16	Year	yyyy	(2009...2099)

## 6.11 Setting or changing the heat program

The heating program is set on line 6 and the heating periods are set on line 7-12.

The heating program can be for the whole week or individual for each weekday. The heating program can have up to three heating periods per day.

First enter the times for the entire week and then change weekdays 6 and 7 as required.

The settings are sorted and overlapping heating periods combined.  
When setting --:-- for the start or the end, the heating period will be inactive.

Line	Function, parameter	Factory setting (range)	Unit
6	Weekday f or entering the heating program	Current weekday (1...7/1-7)	1...7, 1-7 1= Monday 2= Tuesday 1-7= entire week
7	Heating period 1 start	06:00 (--:--/00:00...24:00)	hh:mm
8	Heating period 1 end	22:00 (--:--/00:00...24:00)	hh:mm
9	Heating period 2 start	--:-- (--:--/00:00...24:00)	hh:mm
10	Heating period 2 end	--:-- (--:--/00:00...24:00)	hh:mm
11	Heating period 3 start	--:-- (--:--/00:00...24:00)	hh:mm
12	Heating period 3 end	--:-- (--:--/00:00...24:00)	hh:mm

## 6.12 Reading of temperatures, actual value





Line	Function, parameter	Unit
24	Room temperature	°C
25	Outside temperature	°C
26	D.h.w. temperature	°C
27	Flow temperature heating circuit	°C



## 7 Settings on the heating engineer's level



### 7.1 Level settings and access rights

The operating lines are assigned to different levels. Assignment and access are as follows:

Level	Operating line	Access
End-user	1 ... 50	Press  or  , then select the operating lines
Heating engineer	51 ... 150	Press  or  for 3 seconds, then select the operating lines

When changing to the next lower setting level, all settings of the higher setting levels remain active.

### 7.2 Plant configuration

Press  and  simultaneously for 3 seconds, thus activating the Heating engineer's level for setting the plant-related variables. The plant type is looked to 4.  
The End-user level remains activated.

Line	Function, parameter	Unit	Factory setting	Range
51	Plant type		4	Preset, cannot be changed
52	Space heating present		1	
53	Universal sensor		0	
54	Flow switch		0	0: No flow switch installed 1: Flow switch installed
56	Pump kick		1	0 = inactive 1 = active
57	Winter-/summertime changeover	dd.MM	25.03	01.01. ...31.12
58	Summer-/wintertime changeover	dd.MM	25.10	01.01. ...31.12

### 7.3 Pump kick

The pump kick function is activated for 30 seconds every Friday morning at 10:00.

The pump kick is always activated.

The pump kick function can be activated or deactivated on operating line 56. It is recommended that the pump kick function is activated.

#### 7.3.1 Changing between summer and winter time

The change from wintertime to summertime, and vice versa, is made automatically. The relevant changeover dates can be entered on operating lines 57 and 58.

The entry to be made is the earliest possible changeover date. The weekday on which changeover occurs is always a Sunday

##### Example:

If the start of summertime is specified as "The last Sunday in March", the earliest possible changeover date is March 25. In that case, the date to be entered on operating line 57 is 25.03.

If no summer-/wintertime changeover is required, the 2 dates are to be set so that they coincide.

## 7.4 Spaceheating

<b>Line</b>	<b>Function, parameter</b>	<b>Unit</b>	<b>Factory setting</b>	<b>Range</b>
61	Heating limit (ECO)		-----	ECO- inactive
62	Building structure		1	0/1
63	Quick setback with room sensor		1	0....15
69	Heat gains	K	0	-2....+4
70	Room temperature influence (gain factor)		10	0...20
71	Parallel displacement of heating curve	K	0.0	-4,5...+4,5
72	Overrun time heating circuit pump	min	4	0....40
74	Max. limitation of room temperature	K	-----	- - - / 0,5...4

## 7.5 Actuator heating circuit

<b>Line</b>	<b>Function, parameter</b>	<b>Unit</b>	<b>Factory setting</b>	<b>If floor heating</b>
91	Actuator running time, heating circuit	S	150	
92	P-band, heating circuit	K	35	
93	Integral action time, heating circuit	S	150	
95	Maximum limitation of the flow temperature	°C	90	45
96	Minimum limitation of the flow temperature	°C	---	

## 7.6 D.h.w. heating

<b>Line</b>	<b>Function, parameter</b>	<b>Unit</b>	<b>Factory setting</b>
106	D.h.w. priority		4, parallel
111	Actuator Y5 opening time, d.h.w. mixing valve	S	10
112	Actuator Y5 closing time, d.h.w. mixing valve	S	10
113	P-band d.h.w. control	K	65
114	Integral action time d.h.w. control	s	12
115	Derivative action time d.h.w. control	s	40
117	Max. d.h.w. temperature set point	°C	65
124	Load limit when flow switch is actuated	%	40

## 7.7 Test and display

The block "Test and display" contains 3 operating lines that are specifically suited for the function check:

- on operating line 141, all actual values of the sensors can be called up
- on operating line 142, all output relays can be energized, one by one
- on operating lines 49 and 149, all parameters can be reset to their factory settings.

<b>Line</b>	<b>Function, parameter</b>	<b>Factory setting</b>
141	Sensor test	0 (0...9)
142	Relay test	0
143	Display of active limitations	Display function
146	Contact status at terminal H5	Display function
149	Reset of operating lines on the heating engineer level	
150	Software version	Display function

### 7.7.1 Sensor test

All acquired temperature values can be displayed on operating line 141. Check that the values are realistic.

Code	Sensor or unit
0	Outside sensor (B9)
1	Flow sensor (B1)
2	D.h.w. sensor (B3)
3	Not used
4	Not used
5	Radiator return sensor (B71)

Faults in the measuring circuits are indicated as follows:

--- = open-circuit or no sensor connected

ooo = short-circuit

### 7.7.2 Relay test

All relays can be manually energized on operating line 142, enabling their states to be checked:

**NOTE!** Always close the main shutoff valve.

Depending on the valves status when the relay test starts, line 3 must be done before line 2 and line 7 before line 6.



Code	Response or current status	Comment
0	Normal operation (no test)	
1	All relay contacts de-energized	
2	Relay Y1 energized	Radiator valve opens, rotates clockwise.
3	Relay Y2 energized	Radiator valve closes, rotates counter clockwise
4	Relay Q1 energized	Radiator pump starts.
5	Relay Q3/Y7 energized	Not used
6	Relay Y5 energized	Hot water valve opens, rotates clockwise.
7	Relay Y6 energized	Hot water valve closes, rotates counter clockwise.
0	Normal operation (no test)	

End the relay test by selecting one of the options:

- select another operating line
- press one of the operating mode buttons
- automatically after 8 minutes.

### 7.7.3 Resetting the heating engineer level

By selecting operating line 149, all operating lines of the heating engineer level are reset to their default values. This applies to operating lines 61 through 66 and 70 through 123.

1. Select operating line 149.
2. Keep buttons  and  depressed until the display changes. A flashing 0 on the display is the normal state.
3. If 1 appears, the controller has retrieved the factory settings.



The configuration of the plant (operating lines 51 through 55) and operating line 67 through 69 are not changed by resetting the parameters.

### 7.7.4 Software version

The software version can be displayed on operating line 150.

### 7.8 Reset end-user level

If operating line 49 is set to 1, all the current settings on the end-user level operating lines 2...23 are cleared. In that case, the factory settings will be used again.

1. Select operating line 49.
2. Keep buttons  and  depressed until the display changes. A flashing 0 on the display is the normal status.
3. If 1 appears, the controller has retrieved the factory settings.

### 7.9 ModBus communication

RVD144 can communicate with ModBus/RTU (RS485). For more information about ModBus contact Siemens.

## 8 Troubleshooting

### 8.1 Standard values and fault indication on the RVD144

<b>Line</b>	<b>Function, parameter</b>	<b>Factory setting (range)</b>
49	Reset of operating lines on the end-user level	
50	Display of faults	Display function

### 8.2 Fault codes on the RVD144



Faults in the measuring circuits detected by the controller appear on the display as **Er** (Error) and on operating line 50, accompanied by an error code:

<b>Error code</b>	<b>Cause</b>	<b>Tips when fault</b>
10	Fault outside sensor	check that the outside sensor is mounted
30	Fault flow sensor	
40	Fault return sensor on the primary side	
42	Fault return sensor on the secondary side	check line 53, sensor heating return
50	Fault d.h.w sensor / storage tank sensor 1	
61	Fault room unit	
62	Device with wrong PPS identification connected	
86	Short-circuit on the room unit bus (PPS)	

Perform test of sensor inlet socket according to [7.7.1 Sensor test](#).

#### 8.2.1 Fault in heating control system

Fault in the heating control system indicates with .

If the heating control system does not perform satisfactorily, press the button  (manual operation; the lamp will light up). The heat supplied through the control valve can now be adjusted manually using the  buttons. Then get in touch with your service technician to have the fault corrected.

## 9 Electrical installation

### 9.1 Installing the outdoor temperature sensor

Connect the outdoor temperature sensor to the plinth on the mounting plate (if there is a resistor, remove it).

With a conductor area of 0.6 mm<sup>2</sup> the maximum cable length is 50 metres, maximum 5Ω / conductor.



Picture 6

# 10 Electrical circuit diagram

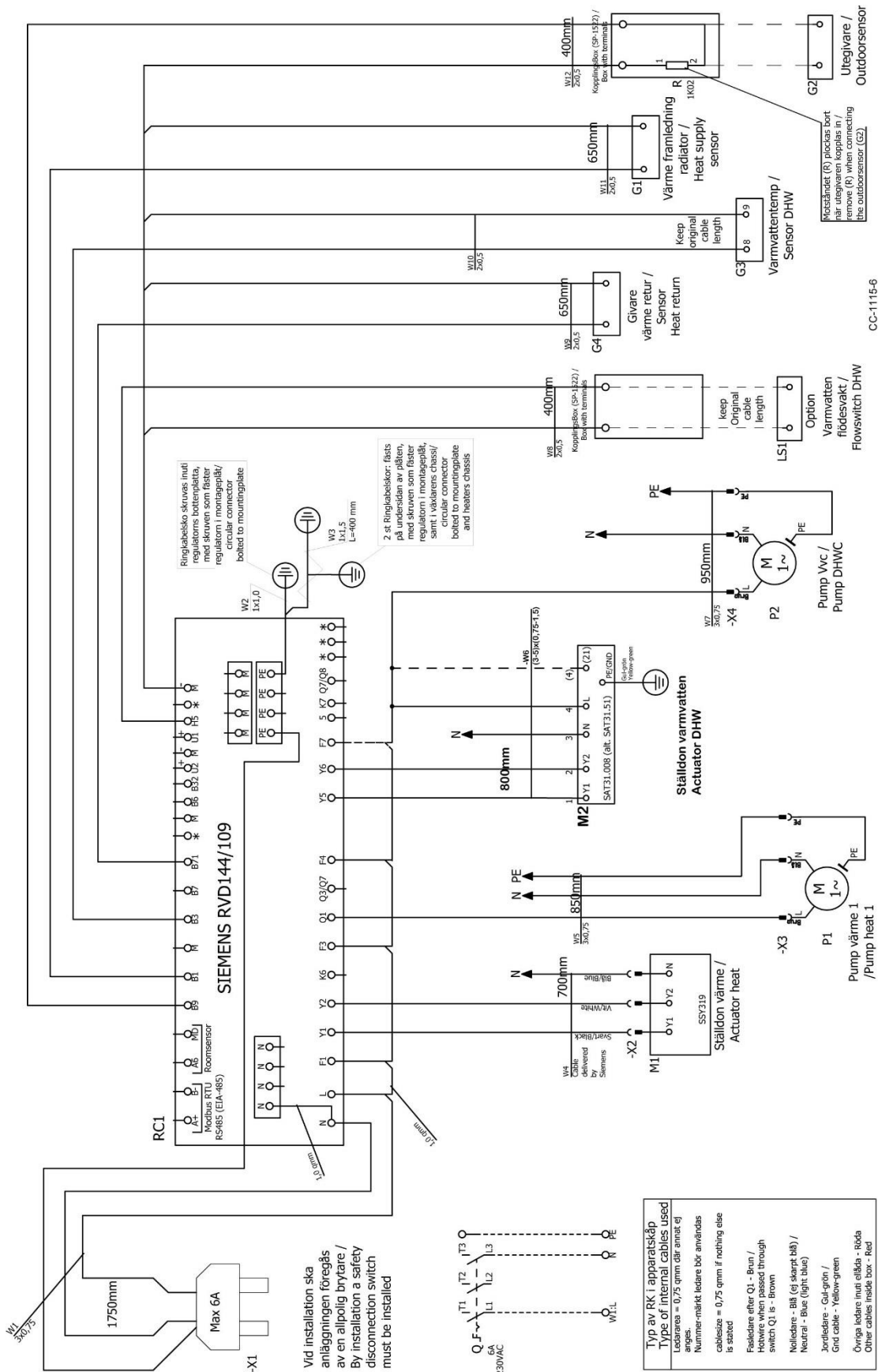

CC-1115-6

Picture 7

# 11 Schematic diagram, main components

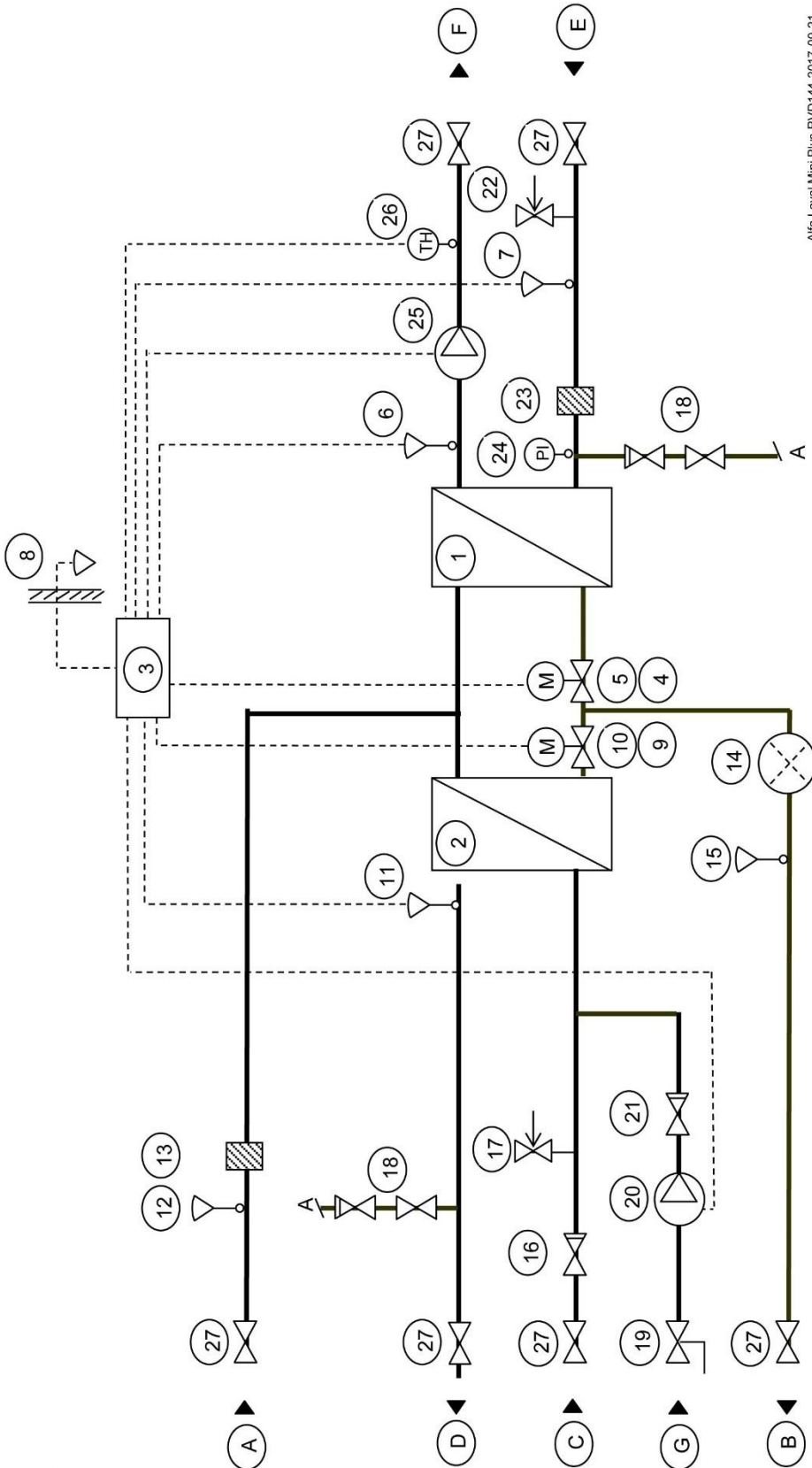

Alfa Laval Mini Plus RVD144-2017-09-21

Picture 8



## 12 Pump settings and pump performance

### 12.1 General

Mini Plus is equipped with two circulation pumps, one for the hot water circulation, DHWC-pump, and one for the heating circuit.

The heating circuit pump is available in two different models.

The DHWC pump is a speed-controlled, high-efficiency pump.

Both heating circuits pumps are pressure-controlled pumps.

### 12.2 DHWC-pump Grundfos UPM3 DHW 15–70 CIL3, capacity

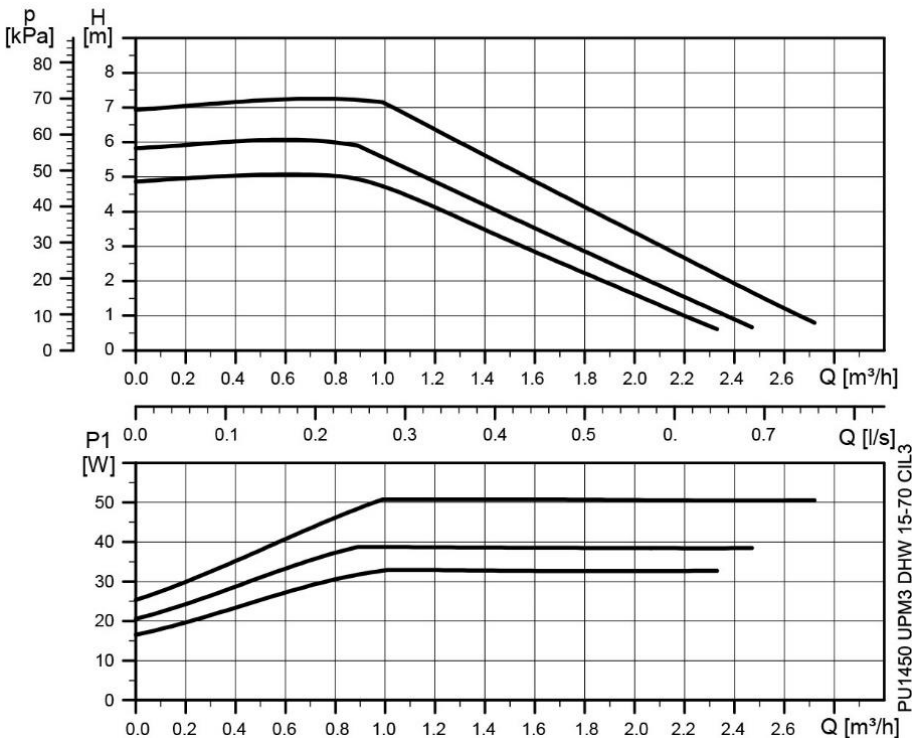

Picture 9

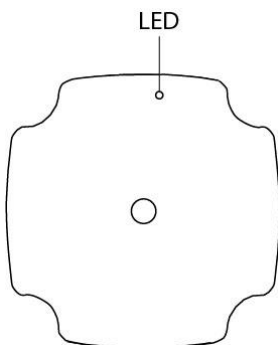

Picture 10

	Green LED	Red LED
No external control	●	
External control	● <sup>1)</sup>	
Alarm		●

<sup>1)</sup> 12 flashes per second

### 12.3 Heating circuit pump Grundfos UPM3 Auto 15–70

When the pump is switched on it runs with the factory pre-setting or the last setting.  
 The pump is pre-set to run with operation mode, **proportional pressure mode 2, PP2**.

Operation mode indicates with LEDs on the pump front.

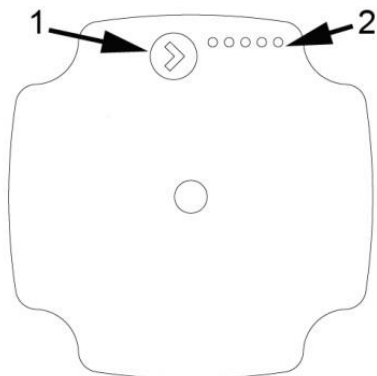



- 1 Push button
- 2 LEDs

Picture 11

The user interface shows with LED:

- operation status
- alarm status

#### 12.3.1 Alarm status

Display	Indication	Pump operation	Counter action
	Rotor is blocked	Trying to start again every 1.33 seconds.	Wait or deblock the shaft.
	Supply voltage too low.	Only warning, pump runs.	Control the supply voltage.
	Electrical error.	Pump is stopped because of low supply voltage or serious failure.	Control the supply voltage / Exchange the pump.

### 12.3.2 Changing the control mode

To set the product, use the button on the operating panel. Every time you press the button, the pump setting is changed. The LEDs will indicate the chosen control mode.

	OPERATING PANEL	CONTROL MODE
0	● ○ ○ ○ ○	PROPORTIONAL PRESSURE AUTO ADAPT
1	○ ● ○ ○ ○	CONSTANT PRESSURE AUTO ADAPT
2	● ○ ● ○ ○	PROPORTIONAL PRESSURE 1
3	● ○ ● ● ○	PROPORTIONAL PRESSURE 2
4	● ○ ● ● ●	PROPORTIONAL PRESSURE 3 - MAX
5	○ ● ● ○ ○	CONSTANT PRESSURE 1
6	○ ● ● ● ○	CONSTANT PRESSURE 2
7	○ ● ● ● ●	CONSTANT PRESSURE 3 - MAX
8	○ ○ ● ○ ○	CONSTANT CURVE 1
9	○ ○ ● ● ○	CONSTANT CURVE 2
10	○ ○ ● ● ●	CONSTANT CURVE 3 - MAX

Picture 12

#### Proportional-pressure curve

The head (pressure) is reduced at falling heat demand and increased at rising heat demand.

The duty point of the pump will move up or down on the selected proportional-pressure curve, depending on the heating demand.

- PP1 is the lowest and PP3 is the highest proportional pressure curve
- AUTO<sub>ADAPT</sub> is the highest to lowest proportional pressure curve.

The AUTO<sub>ADAPT</sub> function enables the pump to control the pump performance automatically within a defined performance range.

In Proportional pressure AUTO<sub>ADAPT</sub>, the pump is set to proportional-pressure control.

#### Constant-pressure curve

The head (pressure) is kept constant, irrespective of the heating demand.

The duty point of the pump will move out or in on the selected constant-pressure curve, depending on the heating demand in the system.

- CP1 is the lowest and CP3 is the highest constant-pressure curve
- AUTO<sub>ADAPT</sub> is the highest to lowest constant-pressure curve.

The AUTO<sub>ADAPT</sub> function enables the pump to control the pump performance automatically within a defined performance range.

In constant pressure AUTO<sub>ADAPT</sub>, the pump is set to constant-pressure control.

#### Constant curve

The circulator runs on a constant curve, which means that it runs at a constant speed or power.

The duty point of the circulator moves up or down on the selected constant curve, depending on the heat demand in the system.

- CC1 is the lowest and CC3 is the highest constant curve

### 12.3.3 Pump curve proportional pressure mode 2, PP2

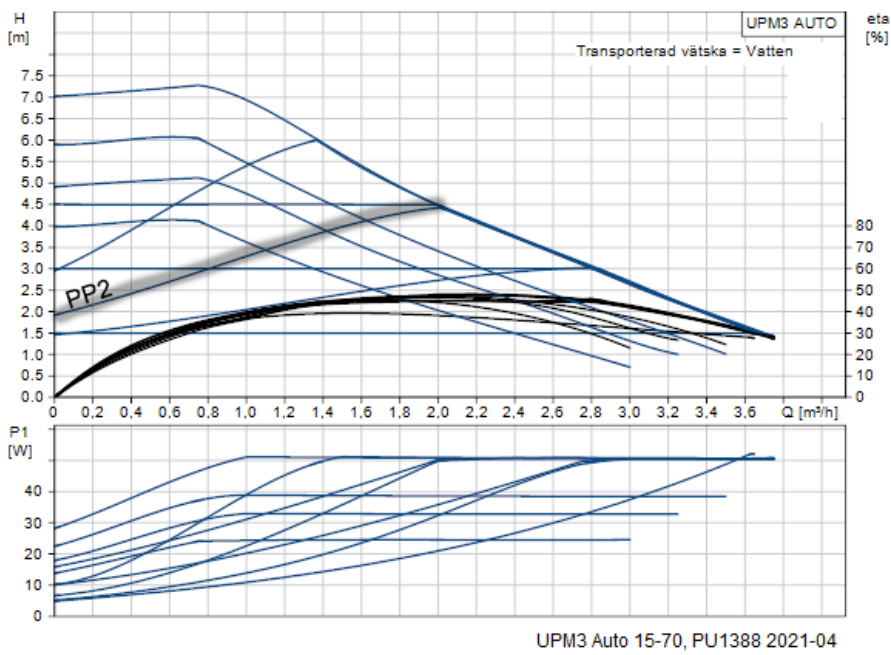

Picture 13

### 12.4 Heating circuit pump Grundfos UPML 25-105 180 Auto, settings and capacity

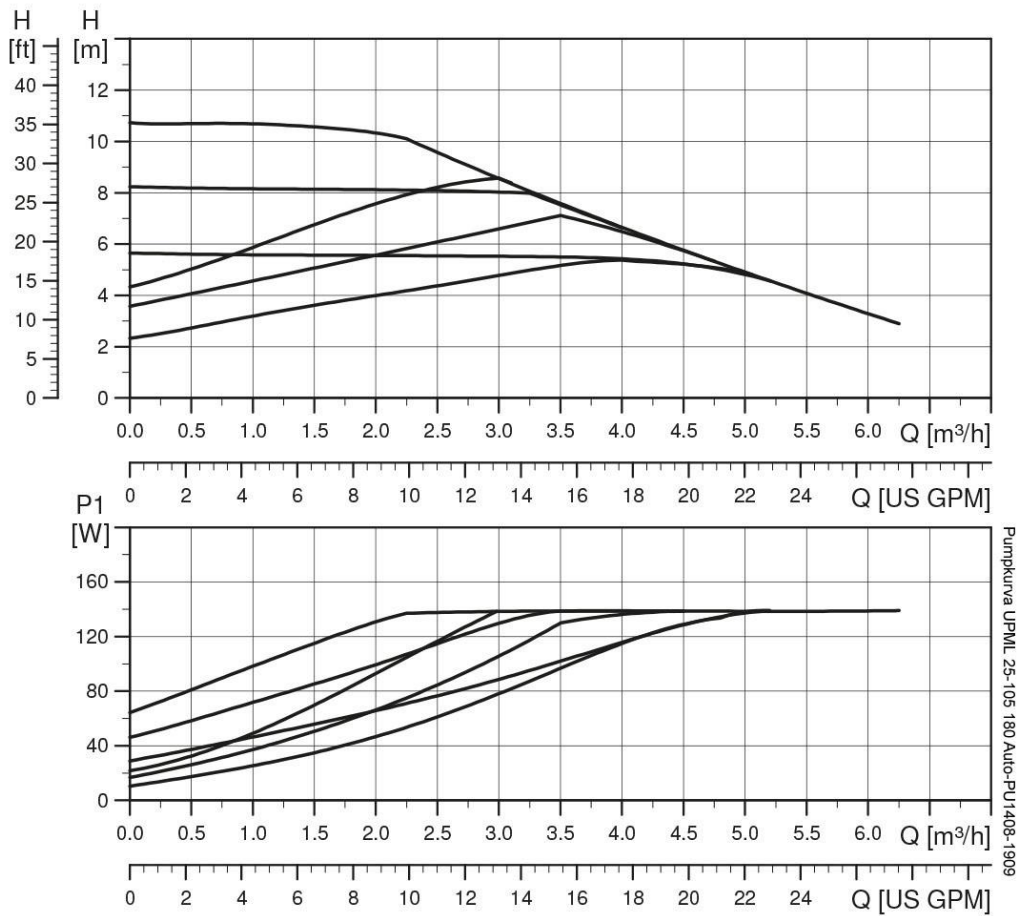

Picture 14

The heating pump is internally controlled via digital pulse-width modulation. The user interface allows to select between six control curves in two control modes:

- three proportional pressure curves (PP)
- three constant pressure/power curves (CP).

The pump is factory preset to Proportional pressure curve, PP2.

Flashing fast III II I	PP1
Flashing fast III II I	PP2
Flashing fast III II I	PP3
Flashing slow III II I	CP1
Flashing slow III II I	CP2
Flashing slow III II I	CP3

Picture 15, LED indication of the curve setting

### 12.4.1 Changing pump curve setting

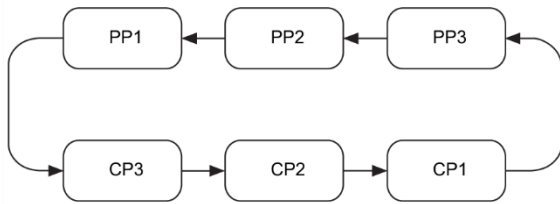

Picture 16, Serial curve setting

1. Push the button for two seconds  
Pump goes to setting mode - LED starts flashing.
2. With each push, the setting changes:  
LED 1-2-3 are permanently on, and then the control curve and mode is changed.
3. Flashing mode:
  - Fast: Proportional pressure
  - Slow: Constant pressure/power
4. After ten seconds not pushing the button:
  - Setting is adapted.
  - Pump returns to operating mode
5. LED 1 or 2 or 3 is permanently on.
  - Pump is running with the selected curve and mode.

## 13 Fault finding pump



Before starting any work at the pump, switch off the power supply. Make sure that the power supply cannot be switched on accidentally.

Be aware that capacitors will be live up to 30 seconds after the power supply has been switched off.

<b>Fault</b>	<b>Cause</b>	<b>Remedy</b>
Pump is not running. No power supply	<ul style="list-style-type: none"> <li>• System is switched off.</li> <li>• A fuse in the installation is blown.</li> <li>• The circuit breaker has tripped.</li> </ul>	<p>Check the system controller.</p> <p>Replace the fuse.</p> <p>Check the power connection and switch on the circuit breaker.</p>
Pump is not running. Normal power supply.	<ul style="list-style-type: none"> <li>• Power supply failure.</li> <li>• Controller is switched off.</li> <li>• Pump is blocked by impurities.</li> <li>• Pump is defective.</li> </ul>	<p>Check the power supply.</p> <p>Check the controller and its settings.</p> <p>Remove impurities. Unblock the pump from the front of the control box with a screwdriver</p> <p>Replace the pump.</p>
Noise in the system.	<ul style="list-style-type: none"> <li>• Air in the system.</li> <li>• Differential pressure is too high.</li> </ul>	<p>Vent the system.</p> <p>Reduce the pump performance at the pump or external controller.</p>
Noise in the pump.	<ul style="list-style-type: none"> <li>• Air in the pump.</li> <li>• Inlet pressure is too low.</li> </ul>	<p>Let the pump run. The pump vents itself over time.</p> <p>Increase the system pressure or check the air volume in the expansion tank, if installed.</p>
Insufficient flow.	<ul style="list-style-type: none"> <li>• Pump performance is too low.</li> <li>• Hydraulic system is closed, or system pressure is insufficient.</li> </ul>	<p>Check the external controller and the pump settings.</p> <p>Check the non-return valve and filter. Increase the system pressure.</p>
Pump runs at maximum speed and cannot be controlled	<ul style="list-style-type: none"> <li>• No signal from signal cable.</li> </ul>	<p>Check if the cable is connected to the controller.</p> <p>If it is, replace the cable.</p>

### 13.1 Fault finding UMP3 pump

<b>Fault</b>	<b>Cause</b>	<b>Remedy</b>
Pump LED5 is on. Pump tries to restart every 1.5 sec.	<ul style="list-style-type: none"> <li>• Rotor shaft is blocked</li> </ul>	<p>Deblock the rotor shaft by pushing it with a screwdriver from the front of the pump.</p>
Pump LED4 is on.	<ul style="list-style-type: none"> <li>• Pump is running.</li> </ul>	<p>Check the supply voltage.</p>
Pump LED3 is on. Pump stops.	<ul style="list-style-type: none"> <li>• Supply voltage is too low.</li> <li>• Serious failure.</li> </ul>	<ul style="list-style-type: none"> <li>• Check the supply voltage.</li> <li>• Exchange the pump.</li> </ul>

## 14 Service instructions



To avoid the risk of scalding, make sure that no-one draws any water while servicing the HIU.



Grey marked service actions must be carried out by an authorized service technician.

**Note!** Make sure that the Mini Plus had been correctly installed.

### 14.1 Tap water service instructions

#### 14.1.1 Tap water temperature too low

Reason	Action
District heating supply too low	<b>Check the primary inlet temperature</b> The temperature can be checked by means of the energy meter (min 65° C) or at the district heating medium supply. The tap water temperature can be monitored on the control panel display line 26.
Handle on control valve incorrectly positioned	<b>Adjust the handle on the control valve</b> Turn the handle on the control valve for domestic hot water, counter clockwise to increase and clockwise to decrease the tap water temperature until the desired tap water temperature is reached (55° C approx.). The stabilisation time for the hot water temperature is about 20 seconds.
District heating filter clogged	<b>See 16.1 <i>Cleaning the district heating filter.</i></b>
Hot water valve and actuator does not work	<b>See 15.1 <i>Check the function of the valve for hot water.</i></b>
Balancing valve DHWC may need to be adjusted	<b>Check and adjust the DHWC balancing valve</b> Check that the balancing valve is open enough.

#### 14.1.2 Tap water temperature too high

Reason	Action
Handle on control valve incorrectly positioned	<b>Adjust the handle on the control valve</b> Turn the handle on the control valve for domestic hot water, counter clockwise to increase and clockwise to decrease the tap water temperature until the desired tap water temperature is reached (55° C approx.). The stabilisation time for the hot water temperature is about 20 seconds.
Hot water valve and actuator does not work	<b>See 15.1 <i>Check the function of the valve for hot water.</i></b>



### 14.1.3 Hot water temperature unstable

Reason	Action
Alternating pressure on primary side	<b>Check available differential pressure and temperature at the district heating medium supply.</b> The temperature can be checked by means of the energy meter, minimum 65°C, or at the district heating medium supply.
District heating filter clogged	<b>See 16.1 <i>Cleaning the district heating filter.</i></b>
DHWC pump is not running	<b>Check that the electrical power is on</b> <b>See 15.3 <i>Check the VVC pump</i></b>
The control equipment may need to be adjusted	<b>Check the hot water settings</b> See 6.12 <i>Reading of temperatures, actual value</i> and 6.7 <i>Setting the DHW set point temperature.</i>
Balancing valve DHWC may need to be adjusted	<b>Check and adjust the DHWC balancing valve</b> Check that the balancing valve is open enough

### 14.1.4 Noise in the DHWC system

Reason	Action
The pump capacity is set too high	<b>Reduce the pump capacity</b> The pump has been set at a too high capacity level. Reduce the level by choosing a lower output setting on the pump. The lowest setting is the most economical.
Air in the pump	<b>Vent the pump</b> Set the pump to speed III. Loosen the pump motor end nut to and let it stay opened until the air in the pump is released. When the pump has been vented, i.e. when the noise has ceased, set the pump according to the recommendations.
The pump motor or pump component damaged	<b>See 16.3 <i>Change the complete DHWC pump or pump components.</i></b>

## 14.2 Heating system service instructions

### 14.2.1 Heating system temperature too high or too low

Reason	Action
The pressure in the system is too low or there is not enough water in the heating system	<p><b>Check the pressure on the manometer and top up the system with water</b></p> <p>The pressure should not be below 1.0 Bar in winter time or below 0.6 Bar in summer. The circuit should only be topped up with fresh water when necessary. The water used for topping up contains oxygen which can lead to corrosion in the system. The circuit should therefore be topped up as seldom as possible. Fill up by opening the top up valves until the pressure meter shows desired value, or up to maximum 2.0 Bar. Then close the top up valve. The safety valve opening pressure is 2.5 Bar.</p>
Air in the heating system	<p><b>Bleed the heating system</b></p> <p>Bleed the heating system at highest point in the heating system.</p> <p>The pump is self-venting. Air in the pump may cause noise. This noise ceases after a few minutes run time. Bleed the radiators.</p> <div data-bbox="635 837 1034 1055" style="text-align: center;"> </div> <p>Picture 17</p>
Heating supply temperature sensor and outdoor temperature sensor does not work	<p><b>Check the heating supply temperature sensor and outdoor temperature sensor</b></p> <p>Check that they are correctly sited and working. To confirm that; check line 27 and line 25 on the operator control panel, see <a href="#">6.12 Reading of temperatures, actual value</a>. Check that the specified temperatures are reasonable. If needed a sensor test (see <a href="#">7.7.1</a>) can be done.</p>
The heating control equipment may need to be adjusted	<p><b>Check and adjust the heating curve</b></p> <p>See <a href="#">6.6 Setting the temperatures in the heating system</a> and change the heating curve with operating line 5.</p>
Heating valve and actuator does not work	<p><b>See <a href="#">15.2 Check the heating actuator and valve function</a>.</b></p>

**14.2.2 No heating**

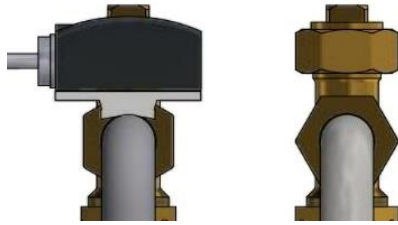
Reason	Action
Circulation pump not running	<b>Check that the electrical power is on</b>
	<b>Check the circulation pump</b> If the pump fails to start after stopping, try to start it at the highest setting. If a UPM3 pump see <a href="#">13 Fault finding pump</a> .
	<b>Check the heating parameters in operator control panel</b> Check the heating parameters, line 6-12. Also, check line 57-58 if the operator control panel is set to summer-winter changeover program.
The pressure in the system is too low or there is not enough water in the heating system	<b>Check the pressure on the manometer and top up the system with water</b> The pressure should not be below 1.0 Bar in winter time or below 0.6 Bar in summer. The circuit should only be topped up with fresh water when necessary. The water used for topping up contains oxygen which can lead to corrosion in the system. The circuit should therefore be topped up as seldom as possible. Fill up by opening the top up valves until the pressure meter shows desired value, or up to maximum 2.0 Bar. Then close the top up valve. The safety valve opening pressure is 2.5 Bar
Air pockets in the HIU or in the heating circuit	<b>Bleed the heating system</b> Bleed the heating system at highest point in the heating system.  The pump is self-venting. Air in the pump may cause noise. This noise ceases after a few minutes run time. Bleed the radiators.  
Heating supply temperature sensor and outdoor temperature sensor does not work	<b>Check the heating supply temperature sensor and outdoor temperature sensor</b> Check that they are correctly sited and working. To confirm that; check line 27 and line 25 on the operator control panel, see <a href="#">6.12 Reading of temperatures, actual value</a> . If needed a sensor test (see <a href="#">7.7.1</a> ) can be done.
Loss of function in the heating control unit.	<b>See <a href="#">15.4 Run the pump manually</a>.</b>
Heating circuit filter clogged	<b>See <a href="#">16.2 Cleaning the heating circuit filter</a>.</b>

Picture 18

#### 14.2.3 Heating system often needs topping up

Reason	Action
Leaks in the HIU or in the system	<b>Check the HIU and the system for leaks</b> Leaks from the HIU or the heating system cause pressure drop. Contact your service technician if finding any leaks.
The heating system safety valve is leaking or does not work	<b>Check the heating system safety valve</b> Check that the heating system safety valve is not leaking and that it works properly. Check the safety valves' function by turning the red wheel/knob until water runs out of the valve's waste pipe and then close the valve quickly.
The expansion vessel cannot handle the changes in the system	<b>See 15.5 Check the volume take-up and pressure equalizing of the expansion vessel.</b>

#### 14.2.4 Heating temperature unstable

Reason	Action
Alternating pressure on primary side	<b>Check available differential pressure and temperature at the district heating medium supply</b> The temperature can be checked by means of the energy meter, minimum 65°C, or at the district heating medium supply.
District heating filter clogged	<b>See 16.1 Cleaning the district heating filter.</b>
Heating supply temperature sensor and outdoor temperature sensor does not work	<b>Check the heating supply temperature sensor and outdoor temperature sensor</b> Check that they are correctly sited and working. To confirm that; check line 27 and line 25 on the operator control panel, see 6.12 Reading of temperatures, actual value. If needed a sensor test (see 7.7.1) can be done.

#### 14.2.5 Noise in the radiator system

Reason	Action
The pump capacity set too high	<b>Reduce the pump capacity</b> Reduce the level by choosing a lower output setting on the pump.
Air in the DHWC pump	<b>Vent the pump</b> The pump is self-venting. Air in the pump may cause noise. This noise ceases after a few minutes run time.
The pump motor or pump component damaged	<b>See 16.4 Change the complete heating pump or pump components.</b>

## 15 Service actions for the service technician

### 15.1 Check the function of the valve for hot water



Service actions must be carried out by an authorized service technician.



Close the shutoff valves for the **DH supply** and **DH return** together with the **cold** and **hot water**.



After finishing repair; open the shutoff valves. Start with **DH supply** and then the **return** line, to avoid pollutions in the system. Open the valves slowly to avoid pressure surges.

1. Disconnect the power feed to the HIU.
2. Close the shut-off valves.
3. Unscrew the tap water actuator from the control valve.

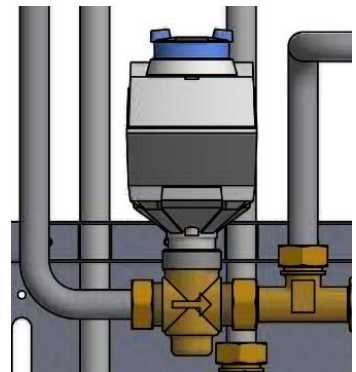

Picture 19

4. Carefully press the valve's spindle with a tool and check the valve's travel and spring back.

**NOTE:** The valve may be very hot!

5. Turn the handle on the actuator; a small dip should move in and out. If the dip does not move the actuator is damaged and requires replacing.
6. Mount the actuator on the valve.
7. Connect the power feed to the HIU.
8. Open the shutoff valves.

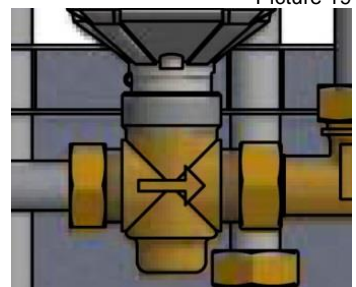

Picture 20

### 15.2 Check the heating actuator and valve function



Service actions must be carried out by an authorized service technician.



Hand maneuver of the heating actuator  
The room thermostat must be without current when maneuvering the actuator by hand.

Check the actuator by doing a relay and sensor test.  
See [7.7.1 Sensor test](#) and [7.7.2 Relay test](#).  
Check the flow using the energy meter while test-running the valve.

If no energy meter is available, disconnect the heating actuator from the valve. Close the actuator by turning the knob counter clockwise, this will make it easier to reattach.

Carefully depress the valve's spindle with a tool and check the valve's travel and spring back.

**NOTE! The valve may be very hot!**

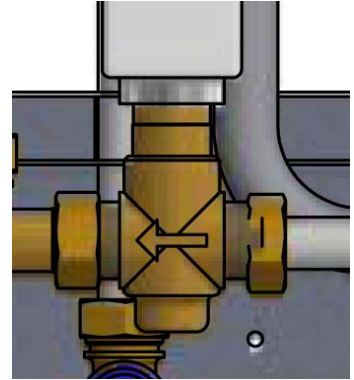

Picture 21

### 15.3 Check the VVC pump

If the pump fails to start after stopping, try to start it at the highest setting.



Service actions must be carried out by an authorized service technician.



Disconnect the power feed to the pump by pulling off the connector before carrying out this task. If the current is on when you use a screwdriver to assist the pump to start, the screwdriver may be wrenched out of your hand when the pump starts.

If the pump does not start, the pump normally can be started by removing the pump motor end nut and helping the pump to start with the aid of a screwdriver in the notch on the engine shaft.

If possible, use a short screwdriver. If the pump is difficult to access, disconnect the heating actuator.

Connect the power feed to the pump and try to start again.



Picture 22

#### 15.4 Run the pump manually



Service actions must be carried out by an authorized service technician.



Hand maneuver of the heating actuator  
The room thermostat must be without current when maneuvering the actuator by hand.

If it necessary to run the pump and actuator manually, this can be done by disconnecting the power to the operator control panel.

1. Disconnect the power feed to the HIU and the power cable to the pump.
2. Connect the replacement cable (option) to the circulation pump.
3. Open the heating valve manually by turning the actuator knob clockwise.  
Open the control valve sufficiently to satisfy the heating needs.
4. Connect the power feed to the HIU.

**Note!** This is a temporary solution until the control unit problem is solved.

#### 15.5 Check the volume take-up and pressure equalizing of the expansion vessel

Check the expansion vessel for possible leakage.

The cause may be that the expansion vessel cannot manage the volume changes on the heating side.  
The expansion vessel may have to be replaced. See [16.12 Change the expansion vessel](#).

Alternatively, the system's total volume of water may be too high, i.e. the volume changes are too large for the expansion vessel. If so, add extra expansion volume.

## 16 Maintenance and repairs

When carrying out repairs, please contact your local service partner.



Before starting out repairs always close the correct shutoff valves.



When dismantling a component there will be water coming out, hot and under pressure.

### 16.1 Cleaning the district heating filter



Service actions must be carried out by an authorized service technician.



The temperature and the pressure of the district heating water are very high. Only qualified technicians can work with the district heating HIU. Incorrect operation may cause serious personal injury and result in damage to the building.



Before starting out repairs close the **DH supply** and **DH return** shutoff valves.



After finishing repair; open the shutoff valves. Start with **DH supply** and then the **return** line, to avoid pollutions in the system. Open the valves slowly to avoid pressure surges.

1. Disconnect the power feed to the HIU.
2. Close the shut-off valves.
3. Use a wrench and release the filter cover and remove the cartridge.
4. Clean the filter with water and refit the cartridge. Screw the filter cover with a momentum of 10-20 Nm.
5. Open the shutoff valves and connect the power feed to the HIU.

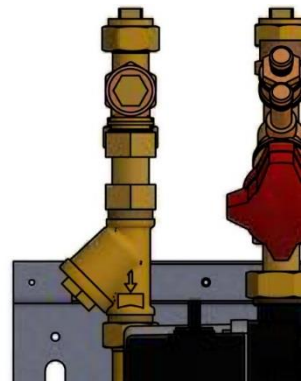

Picture 23

### 16.2 Cleaning the heating circuit filter



Service actions must be carried out by an authorized service technician.



Before starting out repairs, close the shutoff valves **DH supply**, **DH return**, **heating supply** and **heating return**.

Release the pressure using the heating circuit safety valve.



After finishing repair, fill up the circuit and vent.

Then open the shutoff valves, start with **DH supply** and then the **return** line, to avoid pollutions in the system.

Then open **heat return** and then **supply**.

Open the valves slowly to avoid pressure surges.



1. Disconnect the power feed to the HIU.
2. Close the shut-off valves.
3. Use a wrench and release the filter cover and remove the cartridge.
4. Clean the filter with water and refit the cartridge. Screw the filter cover with a momentum of 10-20 Nm.
5. Fill up the heating circuit using the topping up valve, vent the heating circuit.
6. Open the shutoff valves and connect the power feed to the HIU.
7. After final bleeding, the pressure should not be less than 1.0 bar in winter and not less than 0.6 bar in summer.

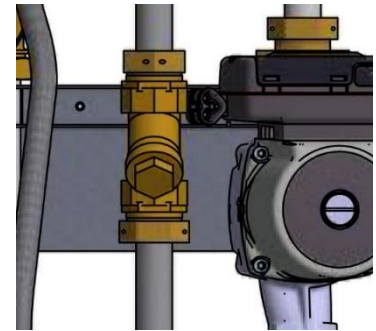

Picture 24

### 16.3 Change the complete DHWC pump or pump components



Maintenance and repairs must be carried out by an authorized service technician.



Before starting out repairs, close the shutoff valves **DH supply**, **DH return**, **cold-water** and **hot water**.

Note the setting of the balancing valve, then close it.  
Release the pressure using the DHWC safety valve.



After finishing repair; fill up the hot water circuit and vent.  
Open the shutoff valves, start with **DH Supply** and then **DH return**, to avoid pollutions in the system. Open the valves slowly to avoid pressure surges.



Check the DHWC circulation.

Change the complete pump or just the pump motor.

1. Disconnect the power feed to the HIU, disconnect the power cable to the pump.
2. Close the shut-off valves and the balancing valve.
3. Choose alternative a or b.
  - a) When changing the complete pump, release the brass nuts with a wrench and replace the pump. Connect the pump cable.
  - b) Only changing the motor, release it by unscrewing four socket head cap screws and replace the motor. Connect the pump cable.
4. Open the shut-off valves cold-water and hot water.
5. Open and adjust the balancing valve.
6. Vent the circuit by opening a hot water tap.
7. Connect the power feed to the HIU.
8. Open the shutoff valves DH Supply and then DH return.

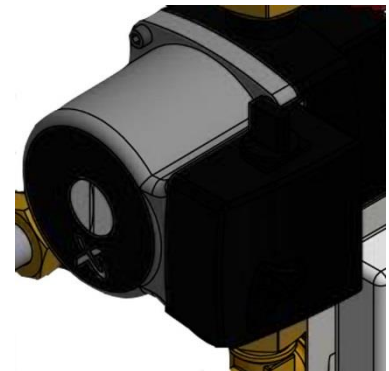

Picture 25

## 16.4 Change the complete heating pump or pump components



Maintenance and repairs must be carried out by an authorized service technician.



Before starting out repairs, close the shutoff valves **DH supply**, **DH return**, **heating supply** and **heating return**.

Release the pressure using the heating safety valve.



After finishing repair; fill up the **heating circuit** and vent.

Open the shutoff valves, start with **heating return** and then **heating supply**, then **DH Supply** and **DH return**, to avoid pollutions in the system.

Open the valves slowly to avoid pressure surges.

Change the complete pump or just the pump motor.

1. Disconnect the power feed to the HIU, disconnect the power cable to the pump.
2. Close the shut-off valves.
3. Choose alternative a or b.
  - c) When changing the complete pump, release the brass nuts with a wrench and replace the pump. Connect the pump cable.
  - d) Only changing the motor, release it by unscrewing four socket head cap screws and replace the motor. Connect the pump cable.
4. Fill up the heating circuit using the top up valves. Vent the heating circuit.
5. Open the shut-off valves and connect the power feed to the HIU.
6. After final bleeding, the pressure should not be less than 1.0 bar in winter and not less than 0.6 bar in summer.

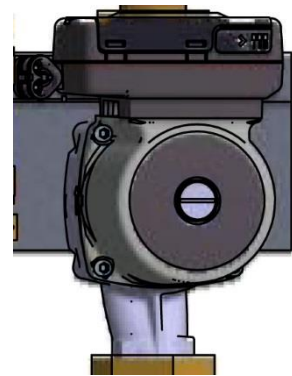

Picture 26

## 16.5 Change the heating supply temperature sensor

1. Disconnect the power feed to the HIU. Close the heating actuator by turning the knob counter clockwise to its closing position.
2. Disconnect the quick-connect terminals and replace the sensor with a new one.
3. Connect the power feed to the HIU.
4. Check the sensors value on the control panel after 5 min.

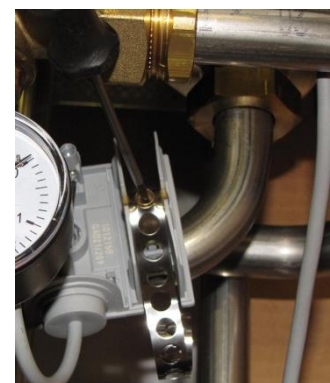

Picture 27

### 16.6 Change the outdoor temperature sensor

1. Disconnect the power feed to the HIU. Close the heating actuator by turning the knob counter clockwise to its closing position.
2. Unscrew the lid by turning it counter clockwise.
3. Unscrew the cables.
4. Loosen the cable fitting.
5. Install a new outdoor temperature sensor.
6. Connect the power feed to the HIU.
7. Check the sensors value on the control panel after 5 min.

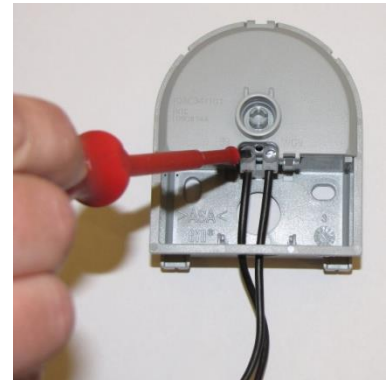

Picture 28

### 16.7 Change the heating actuator



Maintenance and repairs must be carried out by an authorized service technician.

1. Disconnect the power feed to the HIU.
2. Disconnect the electrical power supply to the actuator.
3. Unscrew the heating actuator from the control valve.
4. Cut off all straps that holds the actuator cable.
5. Make sure that new actuator is closed by turning the knob counter clockwise to the closing position. Fasten the actuator, use only hand power.
6. Replace cable and straps.
7. Connect the power feed to the HIU.
8. Check the function of the actuator during start up.

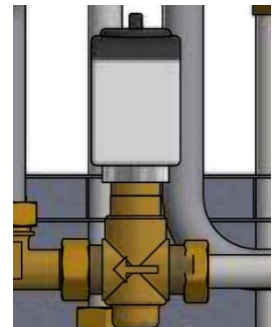

Picture 29

### 16.8 Change the heating valve



The temperature and the pressure of the district heating water are very high. Only qualified technicians can work with the district heating HIU. Incorrect operation may cause serious personal injury and result in damage to the building.



Before starting out repairs close the **DH supply** and **DH return** shutoff valves.



After finishing repair; open the shutoff valves. Start with **DH supply** and then the **return** line, to avoid pollutions in the system. Open the valves slowly to avoid pressure surges.

1. Disconnect the power feed to the HIU.
2. Close the shut-off valves.
3. Unscrew the heating actuator from the control valve.
4. Use a wrench to remove the control valve  
**Note** the arrow direction on the valve.
5. Mount a new valve; and take especially care to the arrow direction.
6. Close the actuator by turning the knob counter clockwise to the closing position. Fasten the actuator, use only hand power.
7. Open the shutoff valves and connect the power feed to the HIU.

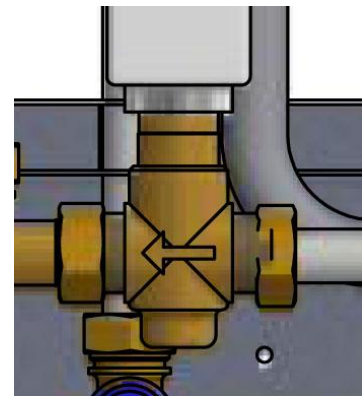

Picture 30

### 16.9 Change the hot water valve



The temperature and the pressure of the district heating water are very high. Only qualified technicians can work with the district heating HIU. Incorrect operation may cause serious personal injury and result in damage to the building.



Before starting out repairs close the **DH supply** and **DH return** shutoff valves.



After finishing repair; open the shutoff valves. Start with **DH supply** and then the **return** line, to avoid pollutions in the system. Open the valves slowly to avoid pressure surges.

1. Disconnect the power feed to the HIU.
2. Close the shut-off valves.
3. Unscrew the tap water actuator from the control valve.

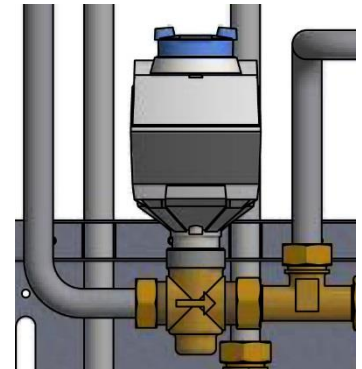

Picture 31

4. Use a wrench to remove the control valve.  
**Note the arrow direction on the valve.**
5. Mount a new valve; and take especially care to the arrow direction.
6. Close the actuator by turning the knob counter clockwise to the closing position. Fasten the actuator, use only hand power.
7. Open the shutoff valves and connect the power feed to the HIU.

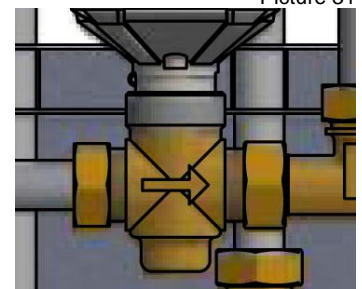

Picture 32

### 16.10 Change the hot water actuator



Maintenance and repairs must be carried out by an authorized service technician.



Disconnecting the power feed to the pump and the HIU.

1. Disconnect the power feed to the HIU.
2. Turn the actuator handle to position 0.
3. Remove the lid by loosening the four screws detach the actuator power supply.
4. Unscrew actuator from the valve.
5. Mount a new actuator and reattach the power supply.

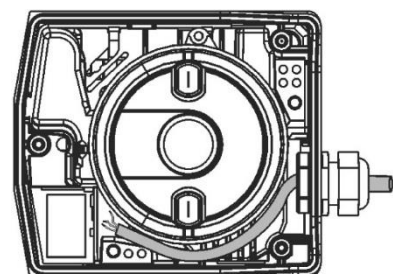

Picture 33

### 16.11 Change the DHWC check valve



Maintenance and repairs must be carried out by an authorized service technician.



Before starting out repairs, close the shutoff valves **DH supply**, **DH return**, **cold-water** and **hot water**.

Note the setting of the balancing valve, then close it.  
Release the pressure using the DHWC safety valve.



After finishing repair; fill up the hot water circuit and vent.  
Open the shutoff valves, start with **DH Supply** and then **DH return**, to avoid pollutions in the system. Open the valves slowly to avoid pressure surges.

1. Disconnect the power feed to the HIU.
2. Close the shut-off valves.
3. Use a wrench and unscrew the pipe between the pump and T-connection.
4. Remove the old check valve and mount a new.  
**NOTE!** Make sure that the check valve is mounted in the correct way.

Flow direction



5. Mount the pipe again.
6. Open the shutoff valves cold and hot water.
7. Open and adjust the balancing valve.
8. Vent the circuit by opening a hot water tap.
9. Connect the power feed to the HIU. Open the shutoff valves DH Supply and then DH return.

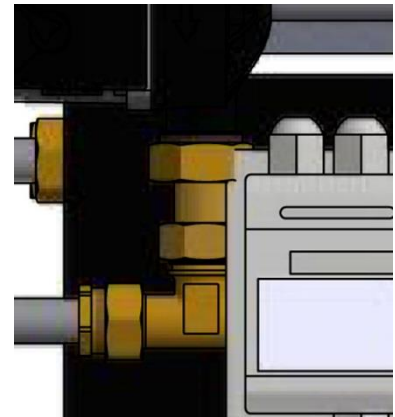

Picture 34

### 16.12 Change the expansion vessel



Maintenance and repairs must be carried out by an authorized service technician.



Before starting out repairs, close the shutoff valves **DH supply**, **DH return**, **heating supply** and **heating return**.

Release the pressure using the heating circuit safety valve.



After finishing repair, fill up the circuit and vent.

Then open the shutoff valves, start with **DH supply** and then the **return** line, to avoid pollutions in the system.

Then open **heat return** and then **supply**. Open the valves slowly to avoid pressure surges.

1. Disconnect the power feed to the HIU.
2. Close the shut-off valves.
3. Replace the expansion vessel.
4. Fill up the heating circuit using the topping up valve, vent the heating circuit.
5. Open the shutoff valves and connect the power feed to the HIU.
6. After final bleeding, the pressure should not be less than 1.0 bar in winter and not less than 0.6 bar in summer.

## 17 Options

The mounting instructions are described for a new installation. If the kits are supposed to be installed on an already installed subsystem, you must release the water pressure and disconnect the electrical power supply before starting.

### 17.1 Safety thermostat

Heating systems sensitive to high temperatures for example under-floor heating must be equipped with a safety thermostat. If the heating system is not equipped with the thermostat, the under-floor heating system and floors in general might get damaged.

1. First disconnect the HIU electrical power supply cable. Disconnect the electrical plug on the circulation pump.
2. Attach the electrical box for under floor heating on the mounting plate.
3. Connect the new power supply cable from the electrical box to the circulation pump.
4. Reconnect the existing power supply cable to the connection on the electrical box.
5. Attach the thermostat to the pipe for heating supply.
6. Set the correct maximum temperature value for the thermostat.
7. Attach all electrical wires with the necessary number of straps. It is important not to attach electrical wires on primary heating pipes and sharp edges.



Picture 35

Set recommended settings for under floor heating systems. Instructions regarding installation parameters see chapter [6.8 Heating Curve](#) and [7.5 Actuator heating circuit](#).

## 18 Operating Data and performance

### 18.1 Operating data Mini Plus CB30-60H

	Primary side	DHW
Design pressure PS	16 Bar	10 bar
Design temperature TS	120°C	90°C
Relief pressure safety-valve	-	9/10 Bar
Volume Heat exchanger, L	1,57 L	1,62 L

Temperature program (°C)									
Heating	Capacity kW	CB type	Plates no	Plates primary	Plates secondary	Flow P l/s	dPp kPa	Flow S l/s	dPs kPa
80-25/10-55 (15,5)	113	30	60	1*9H+2*10H	1*10H+2*10H	0,42	24	0,60	46
80-22/10-55 (15,5)	113	30	60	1*9H+2*10H	1*10H+2*10H	0,42	24	0,60	46
70-25/10-58 (20,2)	100	30	60	1*9H+2*10H	1*10H+2*10H	0,48	32	0,50	32
70-25/10-58	128	30	60	1*9H+2*10H	1*10H+2*10H	0,68	61	0,60	45
65-22/10-55	113	30	60	1*9H+2*10H	1*10H+2*10H	0,63	52	0,60	45
65-22/10-55 (19,7)	82	30	60	1*9H+2*10H	1*10H+2*10H	0,43	26	0,43	25

Mini Plus CB30-60H 2017-10-17

### 18.2 Operating data Mini Plus CB18-54H

	Primary side	Heating
Design pressure PS	16 Bar	6 bar
Design temperature TS	120°C	90°C
Relief pressure safety-valve	-	2,5 Bar
Volume Heat exchanger, L	1,01 L	1,05 L

Temperature program (°C)									
Heating	Capacity kW	CB type	Plates no	Plates primary	Plates secondary	Flow P l/s	dPp kPa	Flow S l/s	dPs kPa
UPML 25-95									
115-65/60-80 (61,48)	60,42	18H	54	1*26 H	1*27 H	0,28	3,0	0,74	20
115-45/40-70 (43,4)	90,1	18H	54	1*26 H	1*27 H	0,32	3,7	0,73	20
115-35/30-35 (30,01)	15	18H	54	1*26 H	1*27 H	0,04	0,1	0,72	20
115-35/30-36 (30,01)	18	18H	54	1*26 H	1*27 H	0,05	0,1	0,72	20
115-35/30-37 (30,02)	21	18H	54	1*26 H	1*27 H	0,06	0,2	0,72	20
100-63/60-80	58,2	18H	54	1*26 H	1*27 H	0,39	5,7	0,71	18,6
100-53/50-70 (52,1)	60,3	18H	54	1*26 H	1*27 H	0,31	3,7	0,73	20
100-48/45-60 (45,68)	45,1	18H	54	1*26 H	1*27 H	0,21	1,7	0,73	20
100-43/40-60 (41,55)	60,1	18H	54	1*26 H	1*27 H	0,26	2,5	0,73	20
100-43/40-70	50	18H	54	1*26 H	1*27 H	0,22	1,9	0,40	6,4
100-43/40-80	20,38	18H	54	1*26 H	1*27 H	0,09	0,3	0,12	0,6
100-33/30-35 (30,01)	15	18H	54	1*26 H	1*27 H	0,05	0,1	0,72	20
100-33/30-36 (30,02)	18	18H	54	1*26 H	1*27 H	0,06	0,2	0,72	20
100-33/30-37 (30,03)	21	18H	54	1*26 H	1*27 H	0,07	0,2	0,72	20
80-55/50-70	43,2	18H	54	1*26 H	1*27 H	0,43	6,9	0,52	10,5
80-63/60-70 (61,65)	30,2	18H	54	1*26 H	1*27 H	0,41	6,3	0,74	20

#### UPM3 15-70

115-65/60-80 (61,2)	52,53	18H	54	1*26 H	1*27 H	0,25	2,3	0,64	15,3
115-45/40-70 (42,9)	79,42	18H	54	1*26 H	1*27 H	0,28	2,9	0,64	15,6
115-35/30-35 (30,01)	13,3	18H	54	1*26 H	1*27 H	0,04	0,1	0,64	15,9
115-35/30-36 (30,01)	15,96	18H	54	1*26 H	1*27 H	0,05	0,1	0,64	15,9
115-35/30-37 (30,01)	18,62	18H	54	1*26 H	1*27 H	0,06	0,1	0,64	15,9
100-63/60-80 (62,7)	52,53	18H	54	1*26 H	1*27 H	0,35	4,6	0,64	15,3
100-53/50-70 (51,8)	52,73	18H	54	1*26 H	1*27 H	0,27	2,8	0,64	15,4
100-48/45-60 (45,56)	39,62	18H	54	1*26 H	1*27 H	0,18	1,3	0,64	15,5
100-43/40-60 (41,3)	52,94	18H	54	1*26 H	1*27 H	0,23	2	0,64	15,6
100-43/40-70	49,63	18H	54	1*26 H	1*27 H	0,22	1,8	0,40	6,3
100-43/40-80	19,86	18H	54	1*26 H	1*27 H	0,09	0,3	0,12	0,6
100-33/30-35 (30,01)	13,3	18H	54	1*26 H	1*27 H	0,05	0,1	0,64	15,9
100-33/30-36 (30,01)	15,96	18H	54	1*26 H	1*27 H	0,06	0,1	0,64	15,9
100-33/30-37 (30,02)	18,62	18H	54	1*26 H	1*27 H	0,07	0,2	0,64	15,9
80-55/50-70	42,84	18H	54	1*26 H	1*27 H	0,42	6,8	0,52	10,3
80-63/60-70 (61,45)	26,25	18H	54	1*26 H	1*27 H	0,35	4,7	0,64	15,2

Mini Plus CB15-54H 2017-10-17





Cetetherm AB  
Fridhemsvägen 15  
372 38 Ronneby - Sweden  
[www.cetetherm.com](http://www.cetetherm.com)

**Cetetherm**  
**NIBE** GROUP MEMBER